

## **A/401679 - METAIS SANITARIOS**

Misturadores e Monocomandos de mesa, para banheiros, cozinhas, etc.  
Material: Latão cromado e outros materiais e acabamentos

## **A/908356 - LINHA TRADICIONAL**

Misturadores e monocomandos de mesa, para banheiros, cozinhas, etc., registros, volantes, etc., jgos. para ducha, chuveiros, válvulas de escoamento, sifões, tubos, ligações flexíveis y acessórios  
Material: Latão cromado, latão niquelado, ABS plástico cromado, aço inoxidável, e outros materiais e acabamentos

## **A/401678 - COLUNAS DE HIDROMASSAGEM**

Material: Aço inoxidável, vidro, PVC, alumínio, madeira, bambu, latão, mármore artificial, etc.

Chuveiro de teto e ducha manual de latão cromado ou plástico cromado

## **A/502233 - CHUVEIROS**

Chuveiros manuais, chuveiros de teto, jgos. de ducha com barra deslizante e mangueira, ducha higiênica, braços  
Material: Latão cromado, aço inoxidável, ABS plástico cromado

Filial No Brasil:

### **PAHCO do Brasil**

Rua 12 de Novembro, 180 - Centro, 3° A, Sala 31  
CEP: 13465-490 Americana (SP) – Brasil  
Tel.: (19) 3621 6070  
Fax: (19) 3621 6073  
[eliane.luis@pahco.de](mailto:eliane.luis@pahco.de)  
[www.pahco.de](http://www.pahco.de)

Matriz na Alemanha:

### **PAHCO GmbH**

Norderoog 1  
28259 Bremen - Germany  
Tel.: +49 / 421 – 5 37 97 – 3  
Fax: +49 / 421 – 5 37 97 –55  
[export@pahco.de](mailto:export@pahco.de)  
[www.pahco.de](http://www.pahco.de)



**FORNECEMOS À IMPORTADORES, DISTRIBUIDORES E RÊDES  
NA AMÉRICA LATINA (origem: Europa e Ásia)**

**LINHA: ART. PARA BANHEIROS, COZINHAS – ACESSÓRIOS, TORNEIRAS,  
VÁLVULAS**

**TORNEIRAS**

- conjuntos para lavatórios e pias, mono-comandos, banheiros e duchas e jogos para bidet
- mangueiras, acessórios e partes
- manipuladores e discos/miolos cerâmicos (vários tipos e materiais)

**VÁLVULAS**

- válvulas de esfera e reguladoras (furo completo ou reduzido – de bronze, zinco, plástico – com manipuladores de alumínio, aço e plástico
- válvulas check, etc. – sob solicitação

**CONEXOES GALVANIZADAS/ACESSÓRIOS PARA TUBOS – DE FERRO MALEÁVEL – PARA  
ÁGUA, ÓLEO, AIR, ETC.**

- galvanizadas a fogo, tipo negro, com rosca americana NPT
- juntas tipo DRESSER

**ACESSÓRIOS DECORATIVOS PARA BANHEIROS**

- peças soltas e em jogos de 5 ou 6 peças.
- acabamento: cromo, cromo-ouro, escovado, etc.

**para uso doméstico e prédios públicos (restaurantes, hotéis, aeroportos, banheiros públicos)**

- Ex.: porta-toalhas, saboneteiras, secadores elétricos, etc.

**Filial No Brasil:**

***PAHCO do Brasil***

Rua 12 de Novembro, 180 - Centro, 3° A, Sala 31  
CEP: 13465-490 Americana (SP) – Brasil  
Tel.: (19) 3621 6070  
Fax: (19) 3621 6073  
[eliane.luis@pahco.de](mailto:eliane.luis@pahco.de)

**Matriz na Alemanha:**

***PAHCO GmbH***

Norderoog 1  
28259 Bremen - Germany  
Tel.: +49 / 421 – 5 37 97 – 3  
Fax: +49 / 421 – 5 37 97 –55  
[export@pahco.de](mailto:export@pahco.de)





Phone: +49 / 4 21 - 5 37 97 -3  
Fax: +49 / 4 21 - 5 37 97 -55  
e-mail: brandes@pahco.de

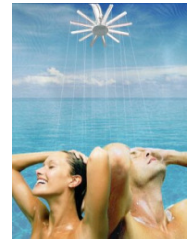

# **TORNEIRAS DE LATÃO CROMADO** **e outros materiais e acabamentos**



**53617**  
8" WALL MOUNTED  
CONCEALED CARTRIDGE  
BASIN FAUCET



**BE20332**  
PLASTIC OBLONG  
(225 X 190 mm )  
SHOWERHEAD  
(RUBBER NOZZLE)

**53615**  
8" WIDESPREAD  
ADJUST TWO HANDLE  
LAVATORY FAUCET



**53653**  
WALL MOUNTED  
CONCEALED CARTRIDGE  
SHOWER FAUCET



**BE20276**  
SQUARE HAND  
SHOWER-HEAD  
WHOLDER



**53667**  
8" WIDESPREAD  
ADJUST TWO HANDLE  
KITCHEN FAUCET



**53644**  
8" CONCEALED  
CARTRIDGE  
BATH FAUCET



**52267**  
8" WIDESPREAD  
ADJUST TWO HANDLE  
KITCHEN FAUCET



**52217**  
8" WALL MOUNTED  
DOUBLE HANDLE  
LAVATORY FAUCET

**BR2241**  
1/2" SHOWER-PIPE



**BE20332**  
PLASTIC OBLONG  
(225 X 190 mm )  
SHOWERHEAD  
(RUBBER NOZZLE)



**52244**  
8" CONCEALED CARTRIDGE  
BATH FAUCET



**BE20276**  
SQUARE HAND  
SHOWER-HEAD  
WHOLDER

**52253**  
WALL MOUNTED  
CONCEALED CARTRIDGE  
SHOWER FAUCET



**52245**  
5-PCS ROMAN TUB SET  
(W/ DIVERTOR & PULL-  
OUT SHOWER SET)



**53645**  
5-PCS ROMAN TUB SET  
(W/ DIVERTOR & PULL-  
OUT SHOWER SET)



**50117**  
8" WALL MOUNTED CONCEALED  
CARTRIDGE BASIN FAUCET



**50145**  
CONCEALED CARTRIDGE  
5-PCS ROMAN TUB SET



**52615**  
8" WIDESPREAD  
ADJUST TWO HANDLE  
LAVATORY FAUCET



**52617**  
8" WALL MOUNTED  
CONCEALED CARTRIDGE  
BASIN FAUCET

**BR2241**  
1/2" SHOWER-PIPE



**BE20332**  
PLASTIC OBLONG  
(225 X 190 mm )  
SHOWERHEAD  
(RUBBER NOZZLE)



**52644**  
8" CONCEALED  
CARTRIDGE  
BATH FAUCET



**BE20276**  
SQUARE HAND  
SHOWER-HEAD  
WIHOLDER

**52653**  
WALL MOUNTED  
CONCEALED CARTRIDGE  
SHOWER FAUCET



**52645**  
5-PCS ROMAN TUB SET  
(W/ DIVERTOR & PULL-  
OUT SHOWER SET)



**53366**  
SINGLE HANDLE  
KITCHEN FAUCET



**53317**  
8" WALL MOUNTED  
DOUBLE HANDLE  
LAVATORY FAUCET



**53331**  
6" WALL MOUNTED  
SHOWER / BATH FAUCET



**53332**  
6" WALL MOUNTED  
SHOWER FAUCET



**53346**  
7" BATH / SHOWER  
MIXER (DECK MOUNTED)



**53347**  
7" BATH FILLER  
(DECK MOUNTED)





**52911**  
*SINGLE HANDLE  
LAVATORY FAUCET*



**52921**  
*SINGLE HANDLE  
BIDET FAUCET*



**52913**  
*DOUBLE HANDLE  
LAVATORY FAUCET*



**52966**  
*SINGLE HANDLE  
KITCHEN FAUCET*



**52931**  
6" WALL MOUNTED  
SHOWER / BATH FAUCET



**52932**  
6" WALL MOUNTED  
SHOWER FAUCET



**BR2219**  
17" BRASS RIGHT ANGLE  
SHOWER ARM W/FLANGE



**BE20332**  
PLASTIC OBLONG  
SHOWERHEAD  
(RUBBER NOZZLE)



**52951**  
CONCEALED SINGLE LEVEL  
SHOWER / BATH VALVE  
(W / DIVERTOR)



**52952**  
CONCEALED SINGLE  
LEVEL SHOWER VALVE



**2151**  
BATH SPOUT



KTL880751-YL



KTL880761



KTL880711-L



KTL880711



KTL880721



KTL880731



KTL880561



KTL880511-L



KTL880521



KTL880511



KTL880132



KTL880152



KTL880162



KTL880112

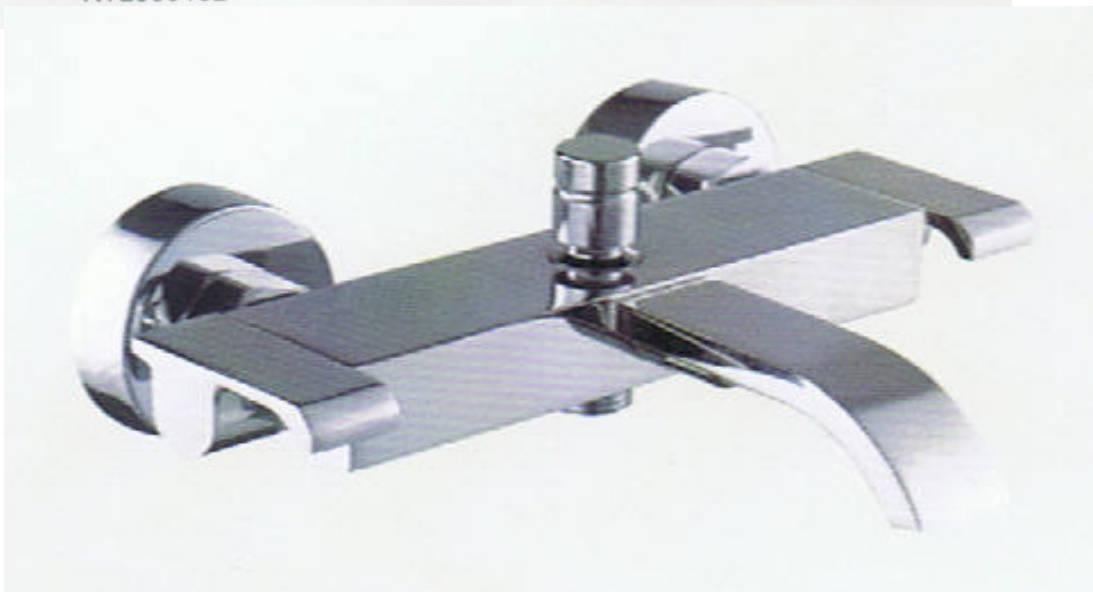



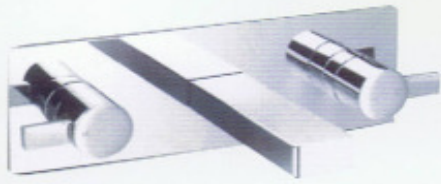

KTL881222-R

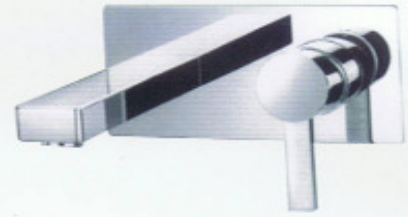

KTL881221-R



KTL881231-R



KTL881282



KTL881272



KTL881282A

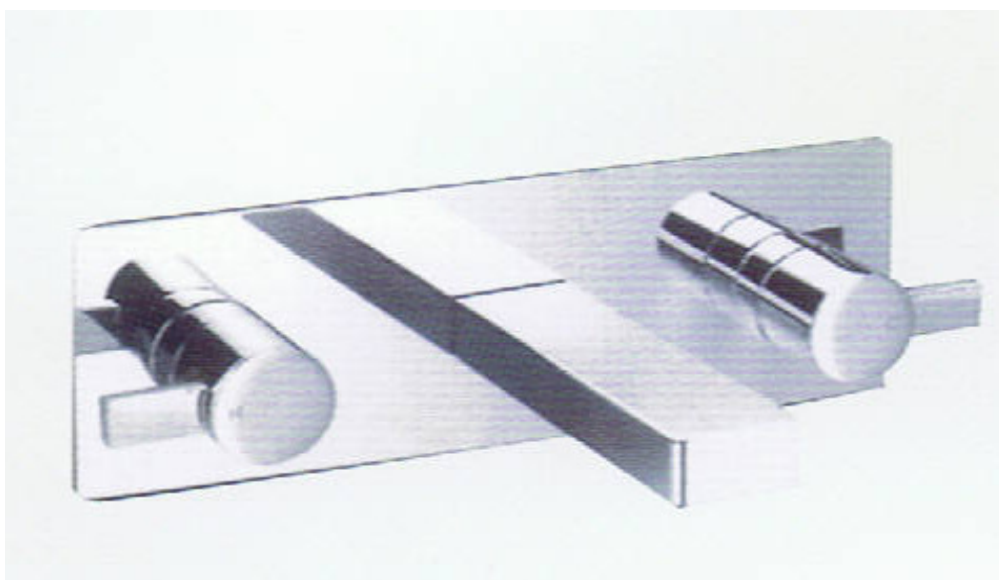



KTL-YG02A-R

KTL-YG02B-R

KTL-YG02C-R

KTL-YG01-F



□ KTL881451-YL



□ KTL881441



□ KTL881431



□ KTL881411



□ KTL881461



□ KTL881461A



□ KTL881511



□ KTL881541



□ KTL881551

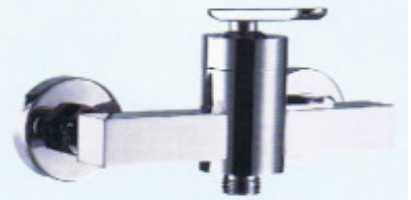

□ KTL881531



□ KTL881561A



□ KTL881561B



□ KTL881561









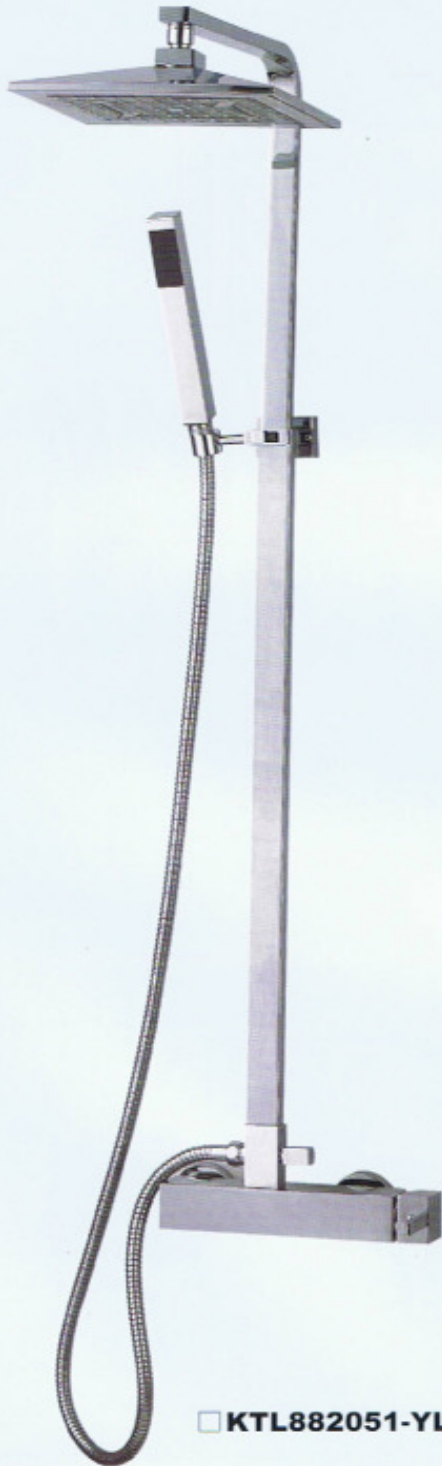

□ KTL882051-YL



□ KTL-MP09



□ KTL882011



□ KTL882031



□ KTL881911-L



□ KTL881961



□ KTL881911



□ KTL881941

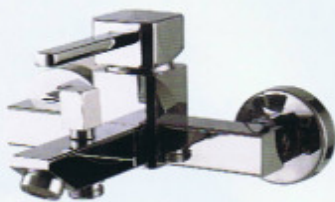

□ KTL881931



□ KTL881951

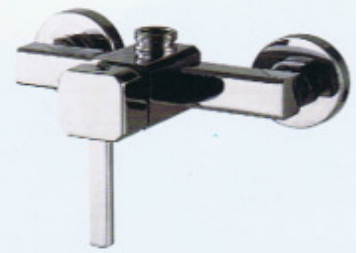

□ KTL881951A





□ KTL81812B-F



□ KTL81812A-F



□ KTL81811A-F



□ KTL81811B-F



□ KTL81712C-F



□ KTL81712A-F



□ KTL81712B-F



□ KTL81711B-F



□ KTL81711A-F



□ KTL81711C-F





□ KTL-CF08



□ KTL-CF09



□ KTL-CF10



□ KTL-CF11



□ KTL-CF12



□ KTL-CF13



□ KTL-CF14



□ KTL-CF15



□ KTL-CF16



□ KTL-CF17



□ KTL-MP13



□ KTL-CF18



□ KTL-CF19



□ KTL-CF20

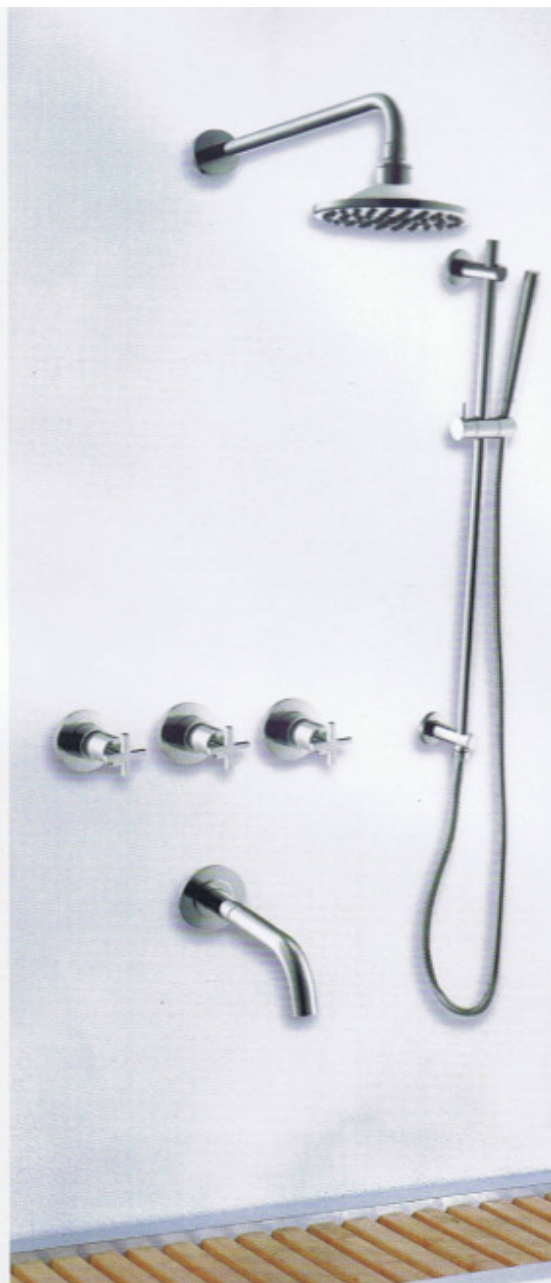

□ KTL-RQ0132





55201  
brushed nicke  
Single lever pull out spray sink-mixer  
monocomando lavello ECO



55202  
brushed nicke  
Single lever pull out spray sink-mixe  
monocomando lavello ECO



55203  
brushed nicke  
Single lever pull out spray sink-mixer  
monocomando lavello ECO





**55207**  
Polished Chrome  
Single lever pull out spray sink-mixer  
monocomando lavello ECO



**55208**  
Polished Chrome  
Single lever pull out spray sink-mixer  
monocomando lavello ECO



**55209**  
Polished Chrome  
Single lever pull out spray sink-mixer  
monocomando lavello ECO



## **A/907841 - TORNEIRAS - DESENHOS MODERNOS**

**Material: Latão cromado, etc.**

**Filial No Brasil:**

***PAHCO do Brasil***

Rua 12 de Novembro, 180 - Centro, Sl.31

CEP: 13465-490 Americana (SP) – Brasil

Tel.: (19) 3621 6070

Fax: (19) 3621 6073

[brasil@pahco.de](mailto:brasil@pahco.de)

[www.pahco.de](http://www.pahco.de)

**Matriz na Alemanha:**

***PAHCO GmbH***

Norderoog 1

28259 Bremen - Germany

Tel.: +49 / 421 – 5 37 97 – 3

Fax: +49 / 421 – 5 37 97 –55

[export@pahco.de](mailto:export@pahco.de)

[www.pahco.de](http://www.pahco.de)

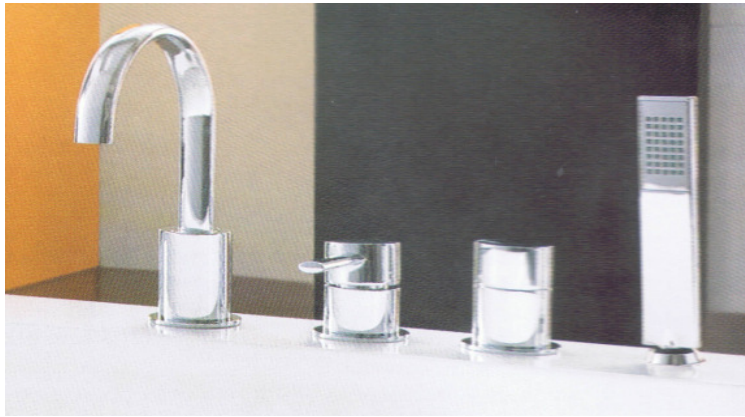

QA28173C



TA56141C

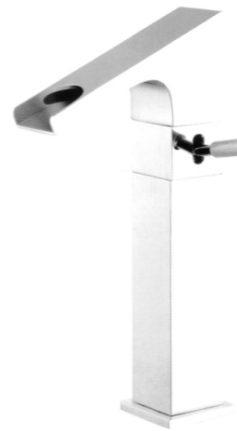

TA16X41C



QA18173C



QA14173C



QA58173C



CA46160C



CA16160C



JA16Z68C



JA16Y68C



CA56147C



CA16X60C



JA16168C



JA16X68C



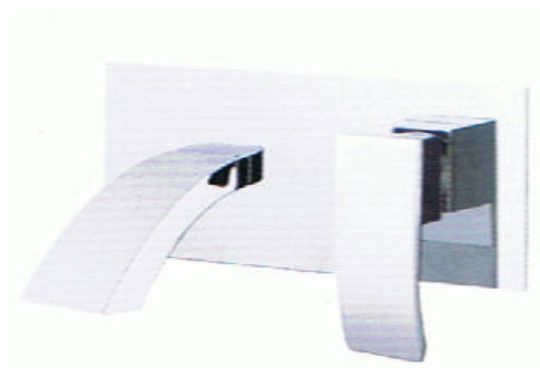

CA14A07C

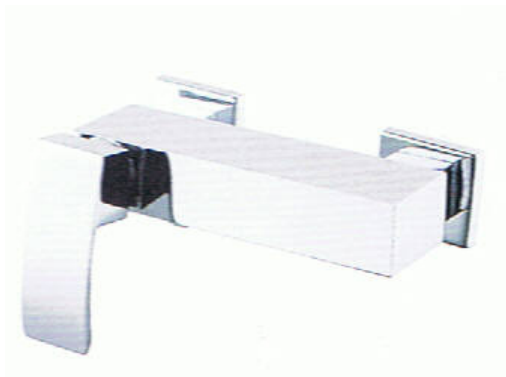

CA33160C



CA23160C



JA56168C



JA46168C



JA33168C



VN16150C

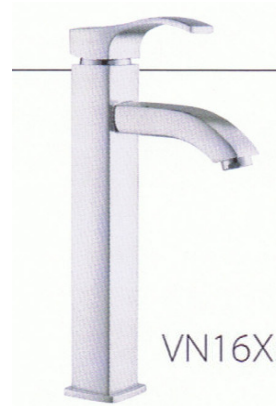

VN16X50C



VN46150C



9J1472-VN34K13C-8W



VN33150C



VN23150C



WM33X47C-1B1464-SH1341

VM34030C-1C1464-PH1341

VM23x47C-2F1464-SH3323



VM16147C



VM16X47C



VM46147C



VM56147C-Y19



VM56147C

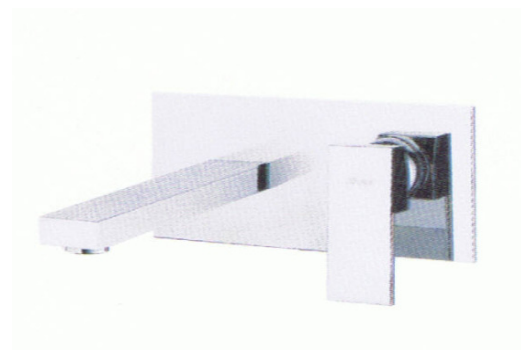

VM14007C

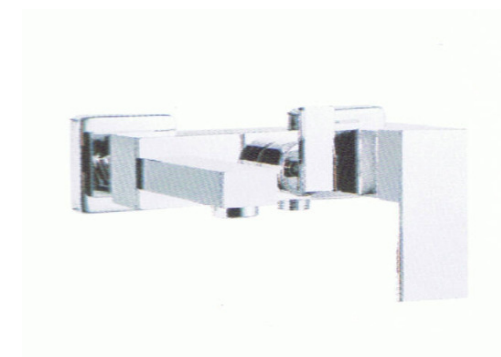

VM33147C



VM23147C





9J1474-VM34K11C



9J1474-VM34K13C-8W

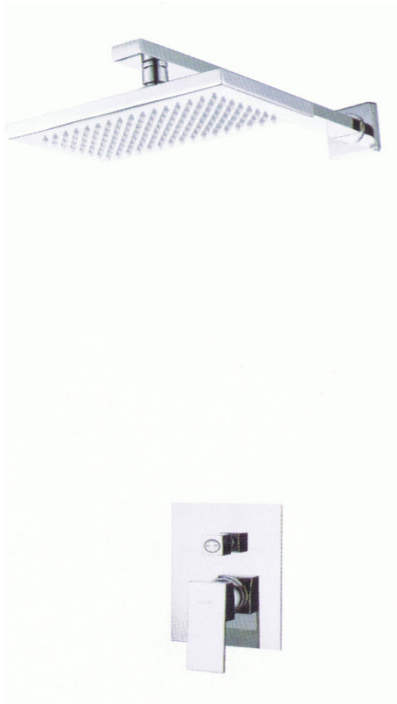

9Q1443-VM34K13C-8W



9J1472-CA34K11C



9Q1443-CA34K13C-8T

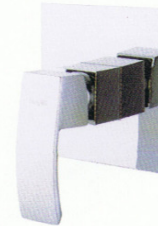





TA16141C



TA14141C

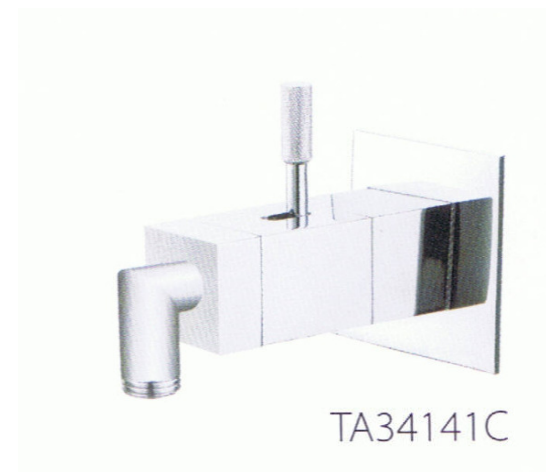

TA34141C



PL16059C



19159N3



58159X2







9E1462-KA34169C



9E1462-KA24169C-7C-AH1351



9E1462-KA24X69C-7D-7C-AH1351

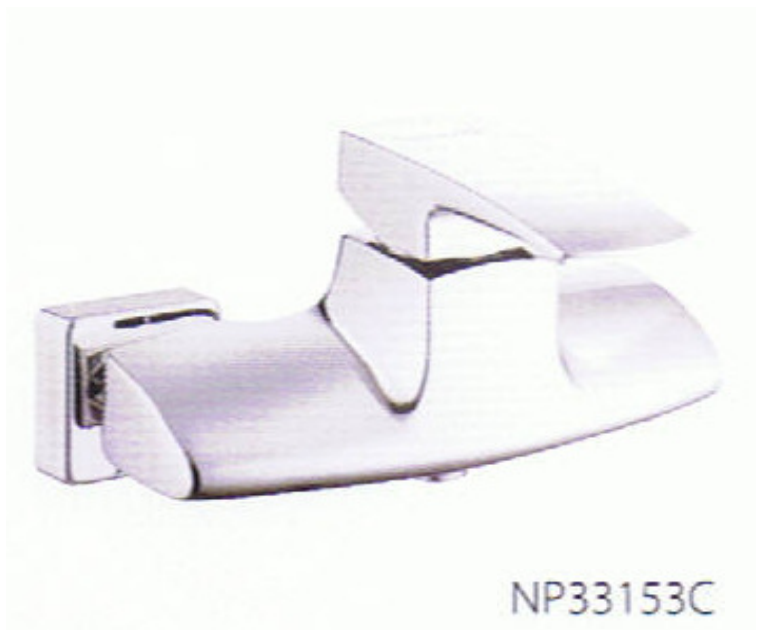





GH33138C



GH23138C



GH16138C



GH46138C



GH56138C





FH16157C



FH46157C



FH56157C



FH33157C

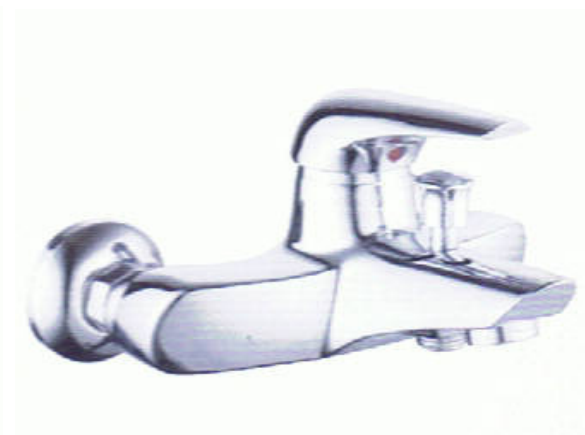

FH23157C



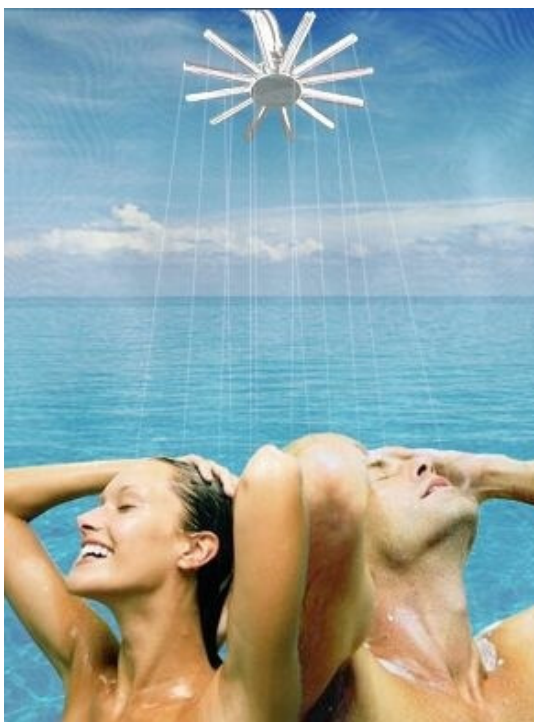

## **A/908356 - TRADITIONAL LINE**

**Lavatory, bath and kitchen faucets  
Handles, spouts, pop-up devices, syphons, tubes, shower hoses  
Shower sets, Shower heads  
Sanitary items and accessories  
Material: c/p brass, stainless steel, zinc, ABS c/p plastic, etc.**

## **A/908356 - LINHA TRADICIONAL**

**Misturadores e monocomandos de mesa, para banheiros, cozinhas,  
Registros, volantes, etc., válvulas de escoamento, sifões, tubos, ligações  
flexíveis e acessórios  
Jgos. para ducha, chuveiros**

**Material: Latão cromado, aço inoxidável, zinco, ABS plástico cromado, etc.**

**Filial No Brasil:**

***PAHCO do Brasil***

Rua 12 de Novembro, 180 - Centro, 3° A, Sala 31  
CEP: 13465-490 Americana (SP) – Brasil  
Tel.: (19) 3621 6070  
Fax: (19) 3621 6073  
[eliane.luis@pahco.de](mailto:eliane.luis@pahco.de)  
[www.pahco.de](http://www.pahco.de)

**Matriz na Alemanha:**

***PAHCO GmbH***

Norderoog 1  
28259 Bremen - Germany  
Tel.: +49 / 421 – 5 37 97 – 3  
Fax: +49 / 421 – 5 37 97 –55  
[export@pahco.de](mailto:export@pahco.de)  
[www.pahco.de](http://www.pahco.de)





**KF001**



**KF011-1**



**KF002-1**



**KF014**



**KF003-1**



**KF012-1**



**KF004-1**



**KF009-1**



**KF005-1**



**KF008-1**



**KF012**

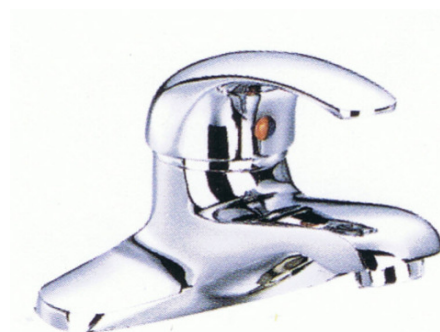

**YZ11010**



**KF010-1**



**KF016**



**KF017-1**



**YZ14021**

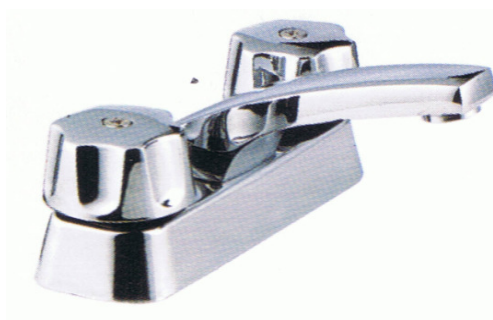

**YZ14009**



**YZ14022**



**KF039**



**YZ14023**



**KF040**



**YZ14025**

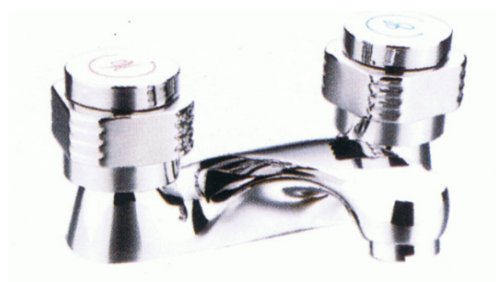

**YZ14018**

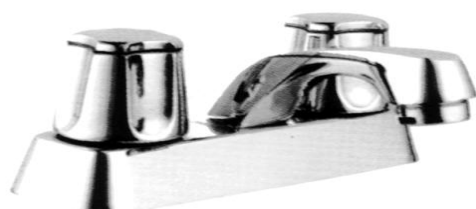

**YZ14026**



**YZ14003**





**YZ14005**



**KF053**



**KF041**



**KF054**



**YZ14001**



**KF055**



**YZ14002**



**YZ14004**



**YZ14006**



**KF056**



**KF042**



**YZ14012**



**YZ14028**



**KF057**



**YZ14029**



**YZ14027**



**YZ14030**



**YZ14024**



**YZ14011**



**KF058**





**KF059**



**KF007-1**



**KF060**



**KF006**



**KF043**



**KF019**



**KF044**



**YZ11002**



**KF018-1**



**YZ11001**



**YZ11001A**



**KF020**



**KF022**



**KF021**



**KF023**

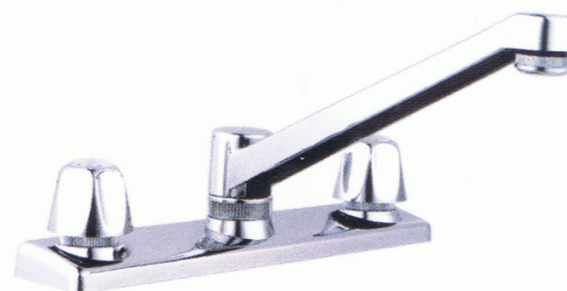

**YZ18036**



**YZ18004**



**YZ18037**

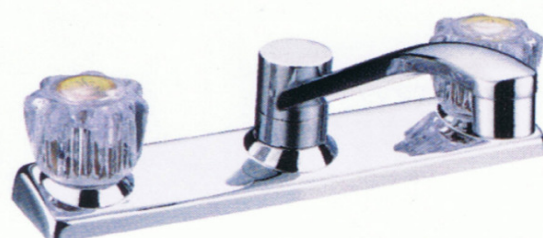

**YZ18001**



**YZ18006**

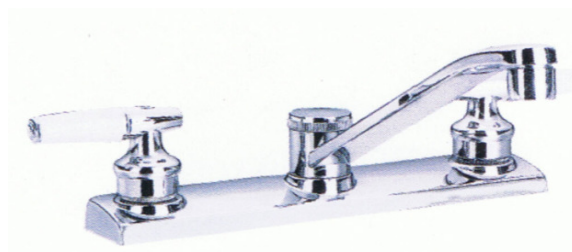

**YZ18003**



**KF025-1**



**KF027-1**



**YZ18023**



**YZ18013**



**YZ18030**





**KF026-1**



**YZ18014**



**YZ18015**



**YZ18008**



**YZ18009**



**YZ18011**





**YZ18010**



**YZ18012**



**KF028**



**YZ12042**



**KF029**

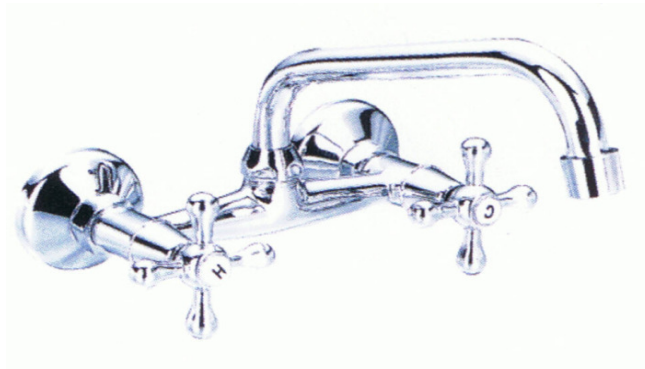

**YZ12050**



**YZ18038**

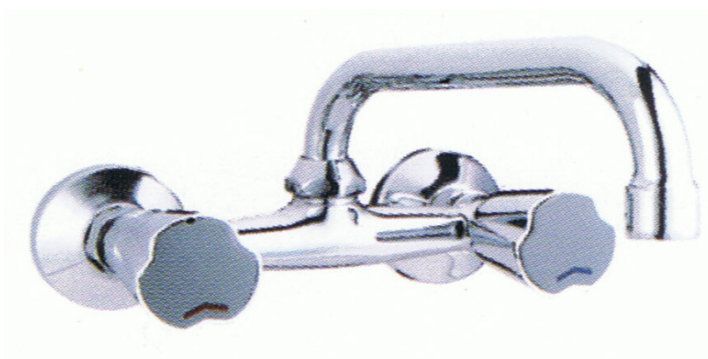

**YZ12013**



**KF030**

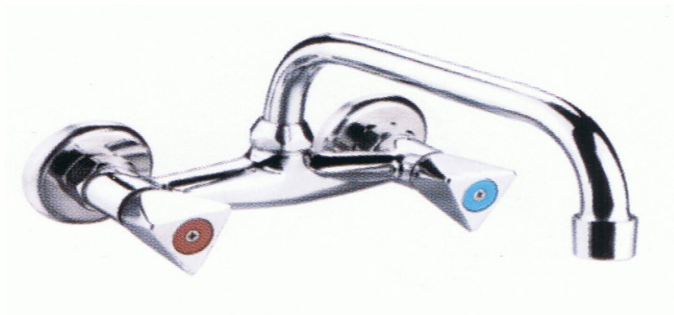

**YZ12027**



**YZ12089**



**YZ12037**



**YZ12045**



**KF033**



**YZ12031**



**KF034**



**YZ12088**



**YZ12053**





**YZ12041**



**YZ12062**

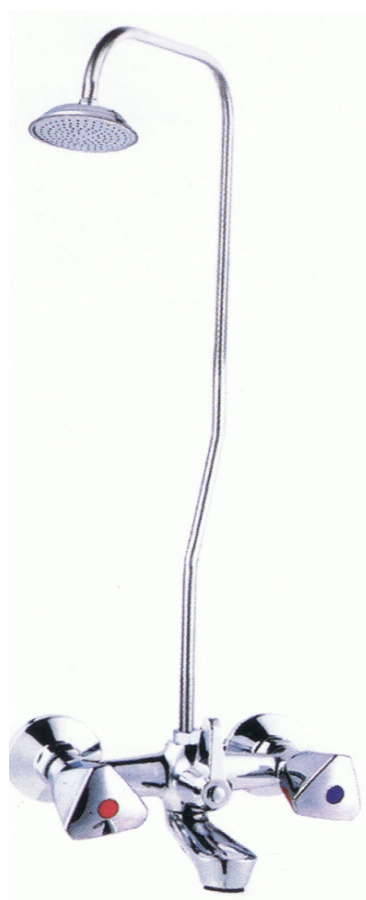

**YZ12061**



**YZ12021**



**YZ12036**

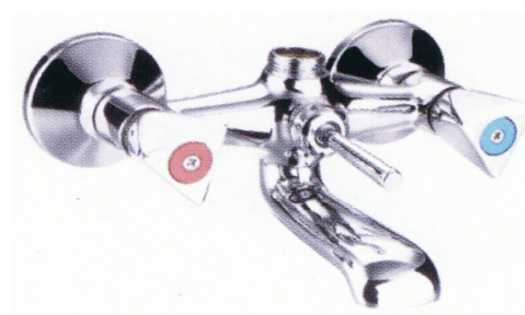

**YZ12026**



**YZ12080**

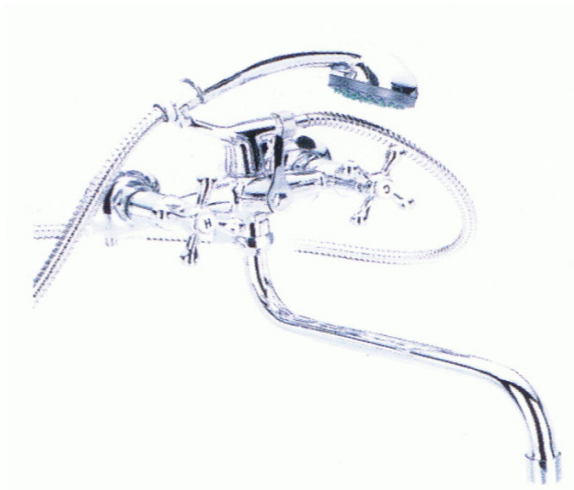

**YZ12049**



**YZ12063**



**YZ12082**

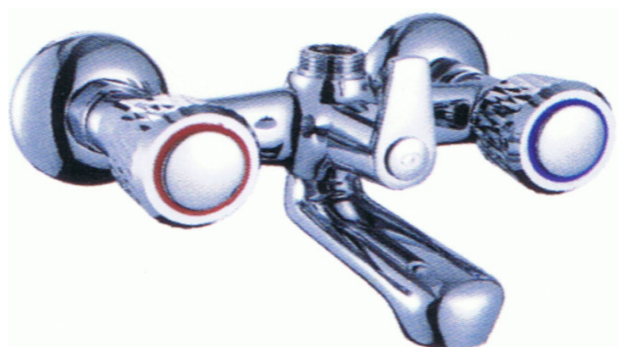

**YZ12057**



**YZ12072**

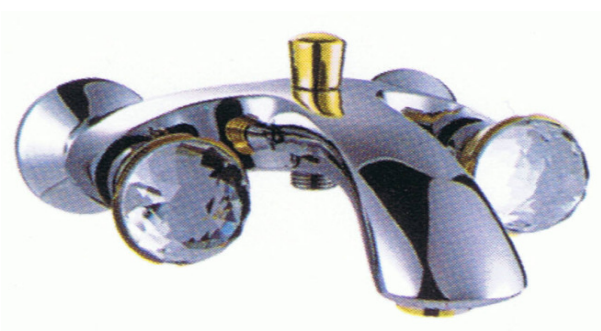

**YZ12092**



**YZ12085**

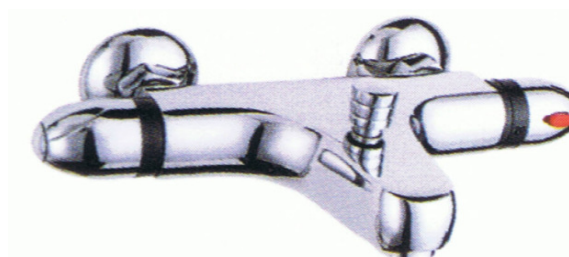

**YZ12096**





**YZ12081**



**YZ12093**

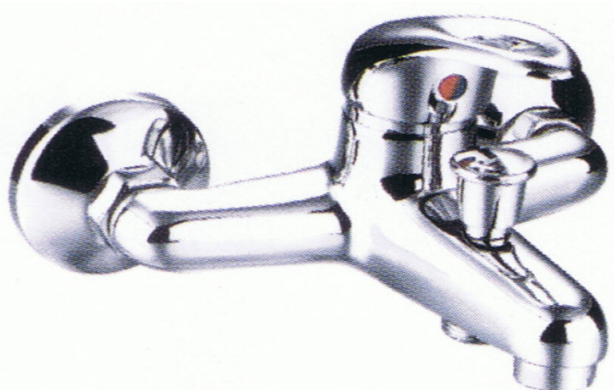

**YZ1109**



**YZ11025**



**YZ11013**

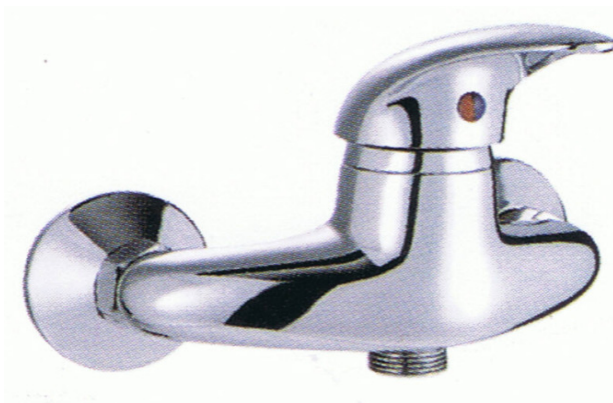

**YZ11019**



**YZ11017**



**YZ11011**

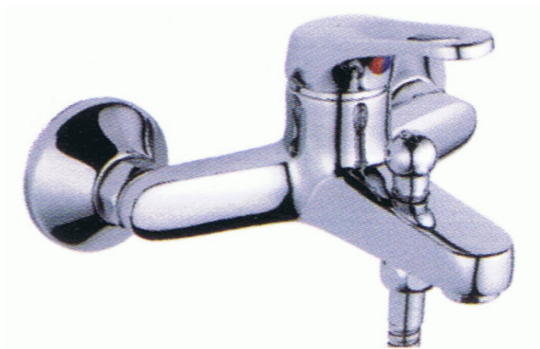

**YZ11021**



**YZ11018**

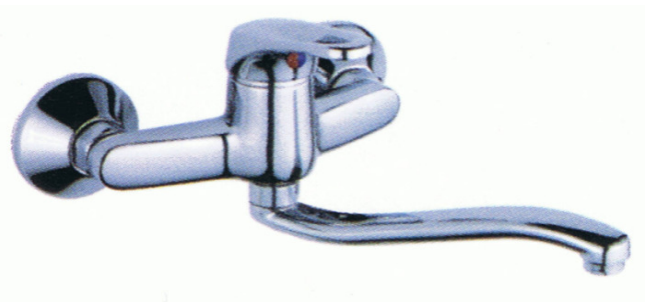

**YZ11026**

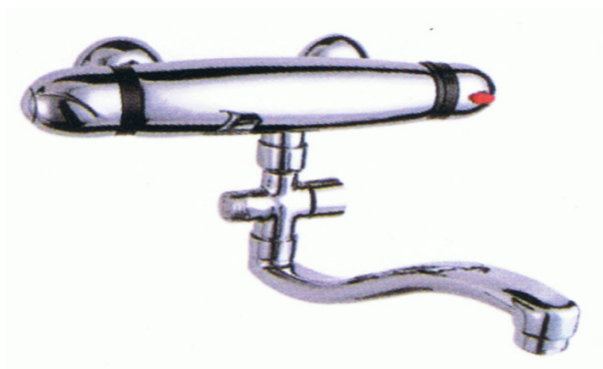

**YZ12097**

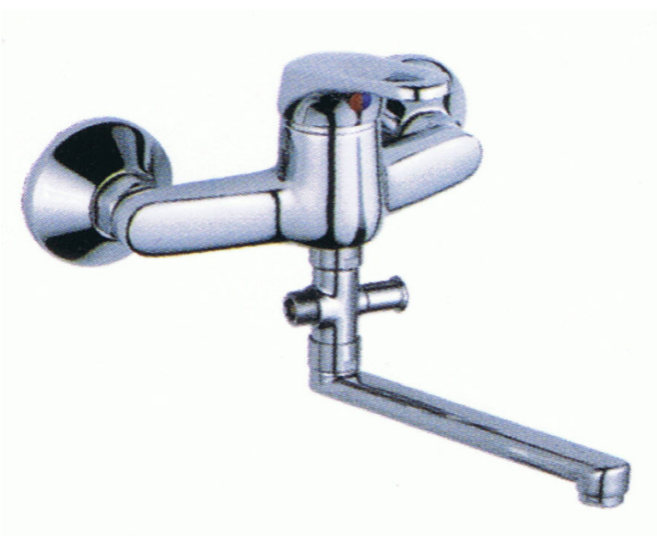

**YZ11023**



**YZ12022**



**YZ11016**



**YZ12064**



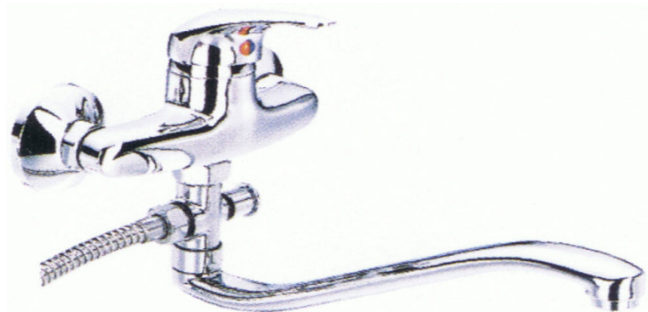

**YZ11012**



**YZ12028**



**YZ12083**



**YZ12032**



**YZ12086**



**YZ12073**



**YZ12090**



**YZ12058**



YZ12029



YZ12074



YZ12051



YZ12087



YZ12067



YZ12091



YZ12070



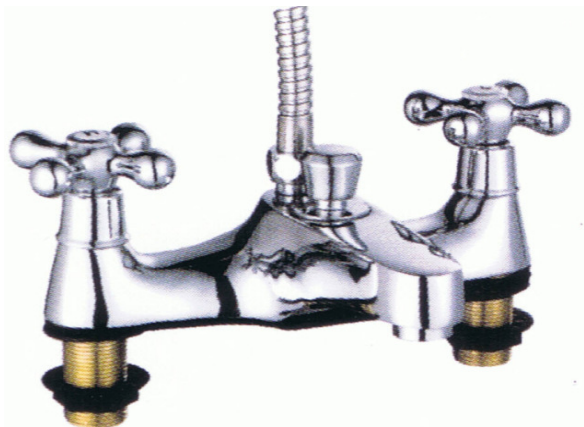

**YZ12076**



**YZ12048**

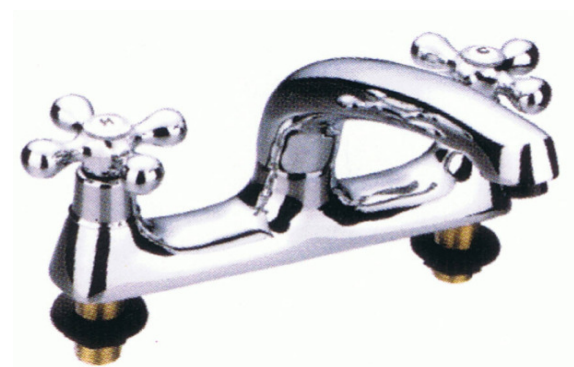

**YZ12077**



**YZ12052**



**YZ12078**



**YZ12056**

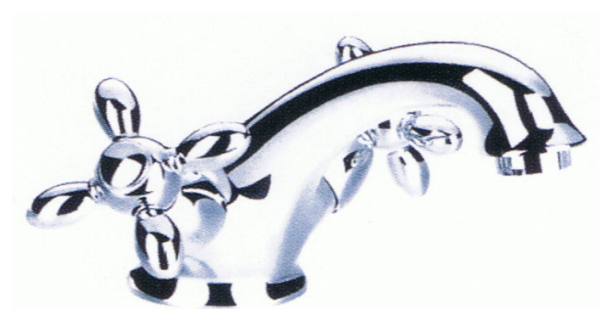

**YZ12043**



**YZ12060**



YZ12044



YZ12024



YZ12034



YZ12059



YZ12023



YZ12094



YZ12033



YZ12095





**YZ12046**



**YZ12054**



**YZ12047**



**YZ12084**



**YZ12069**



**YZ12025**



**YZ12040**



**YZ12035**



**YZ12030**



**YZ1108**



**YZ12071**



**YZ11022**



**YZ12075**



**YZ11024**



**YZ12079**



**YZ11020**





**YZ12055**



**YZ12098**



**YZ12038**



**YZ11014**



**YZ12065**



**YZ11027**



**YZ1266**



**YZ11028**



**YZ12039**

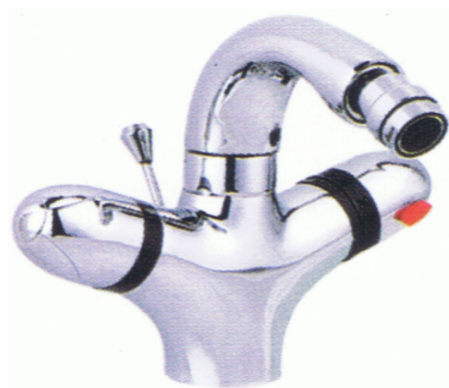

**YZ12099**



**YZ11015**

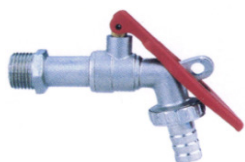

**YZ13006**



**YZ13007**



**YZ13008**



**YZ13009**



**YZ13010**



**YZ13011**



**YZ13012**



**YZ13013**



**YZ13014**



**YZ13015**



**YZ13016**



**YZ13017**



**YZ13018**



**YZ13019**



**YZ13020**



**YZ13021**



**YZ13022**



**YZ13023**



**YZ13024**



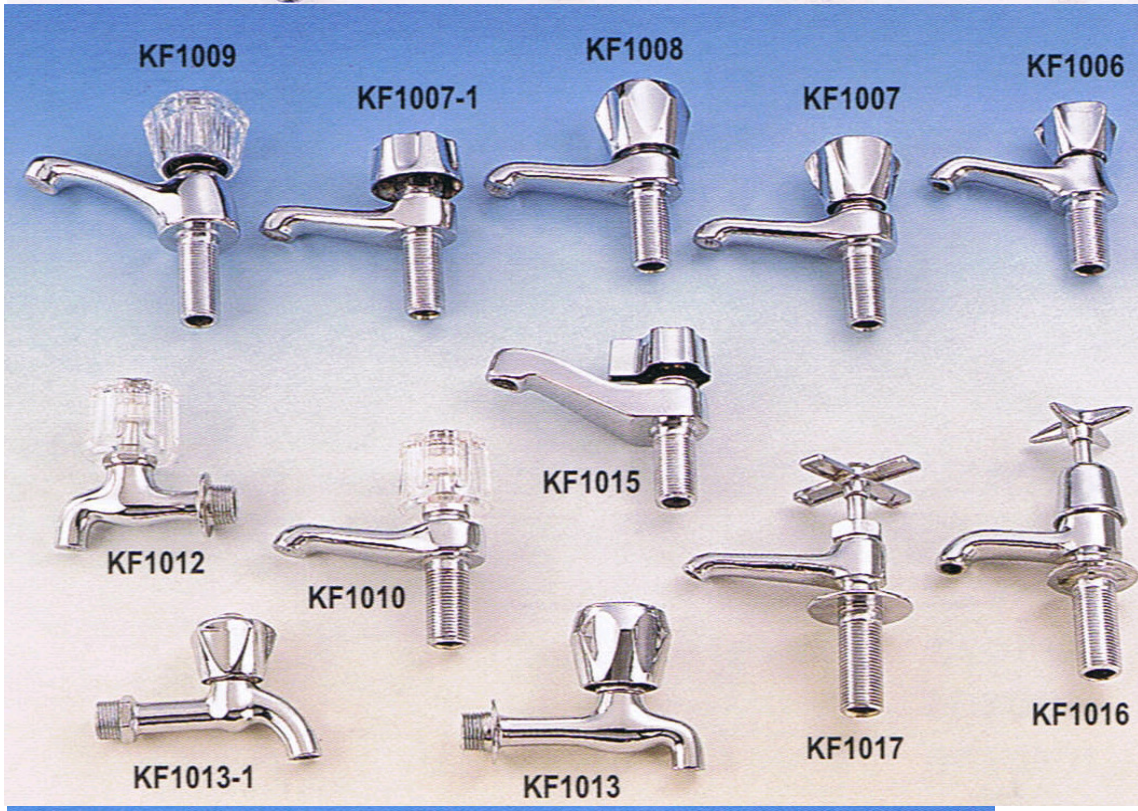
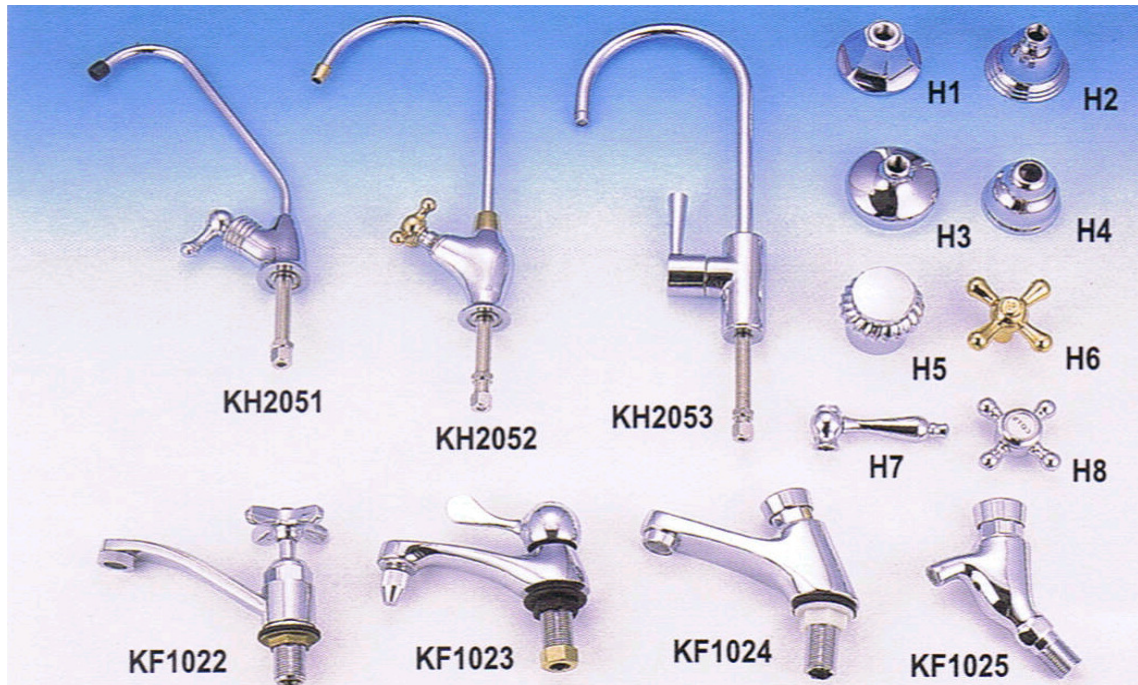









**YZ22001**



**YZ22002**



**YZ22003**



**YZ22004**



**YZ22005**



**YZ22006**



**YZ22007**



**YZ22008**



**YZ22009**



**YZ22010**



**YZ22011**



**YZ22012**

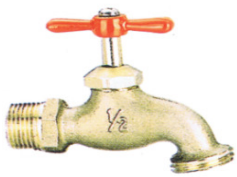

**YZ13001**



**YZ13002**



**YZ13003**



**YZ13004**



**YZ13005**



**YZ24003**



**YZ24004**



**YZ24005**



**YZ24005**



**YZ23001**



**YZ23002**



**KH2002**



**KH2009**

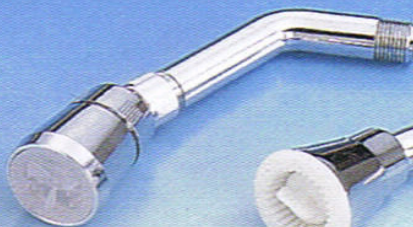

**KH2012**



**KH2011**



**KH2004**



**KH2003**



**KH2003**

**KH2013-1**



**KH2013**



**KH2008**



**KH2007**



**KH2005**



**KH2006**



**KH2008-1**





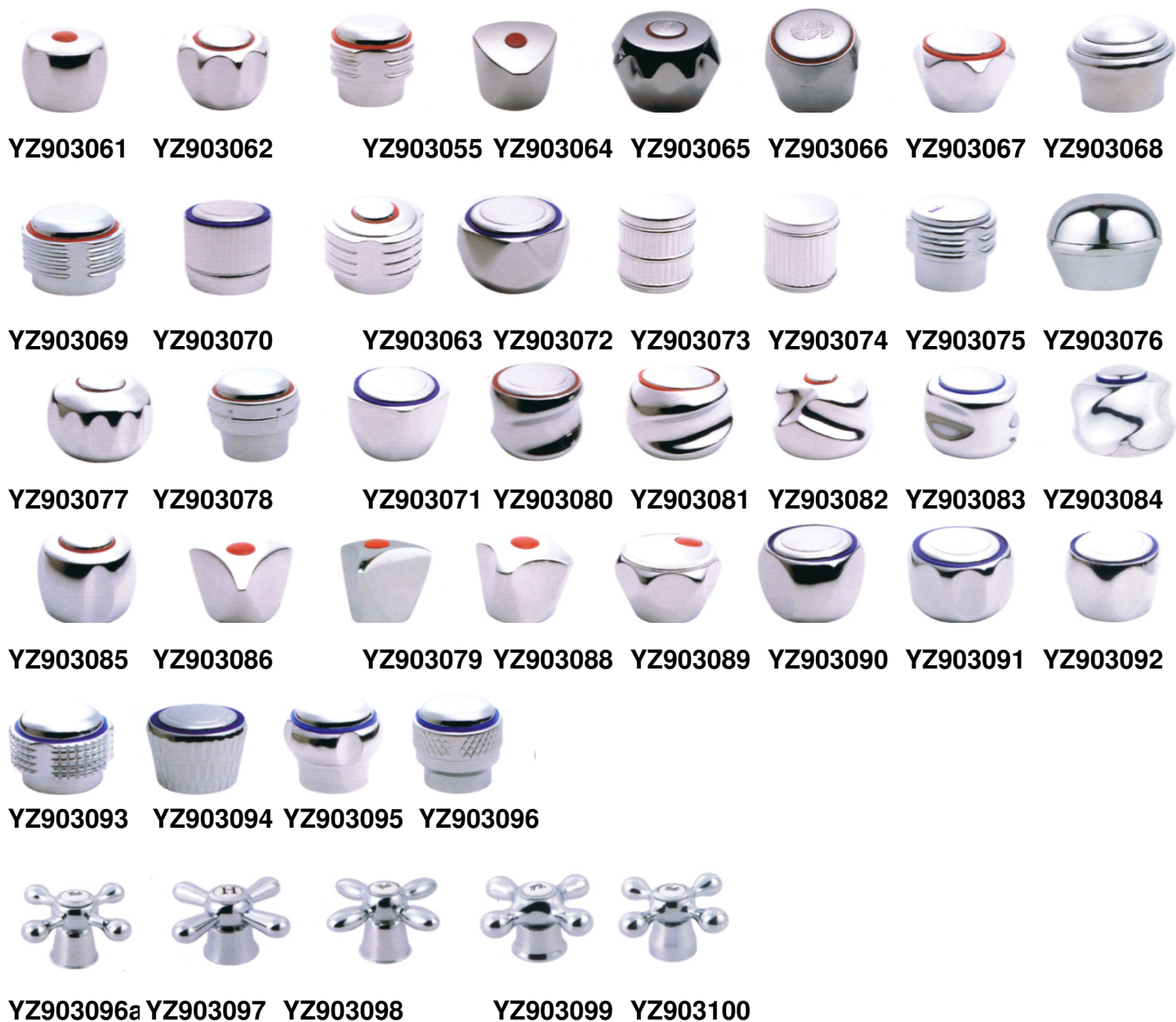





**YZ32009**



**YZ32010**



**YZ32011**



**YZ32012**



**YZ32013**



**YZ32014**



**YZ32015**



**YZ32016**

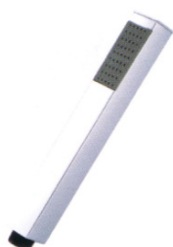

**YZ32017**



**YZ32018**



**YZ32019**



**YZ32020**



**YZ32021**



**YZ32022**



**YZ32023**



**YZ32024**



**YZ32025**



**YZ32026**



**YZ32027**



**YZ32028**



**YZ32029**



**YZ32030**



**YZ32031**



**YZ32032**



**YZ32033**



**YZ32034**



**YZ32035**



**YZ32036**



**YZ32037**



**YZ32038**



**YZ32039**



**YZ32040**



**YZ32041**



**YZ32042**



**YZ32043**



**YZ32044**



**YZ32045**



**YZ32046**



**YZ32047**



**YZ32048**



**YZ32049**



**YZ32050**



**YZ32051**



YZ99904 YZ99905 YZ99906 YZ99907 YZ99908 YZ99909 YZ99910 YZ99911



YZ99912 YZ99913 YZ99914 YZ99915 YZ99916 YZ99917 YZ99918 YZ99919



YZ31008 YZ31009 YZ31010 YZ31011



YZ31012 YZ31013 YZ31014 YZ31015

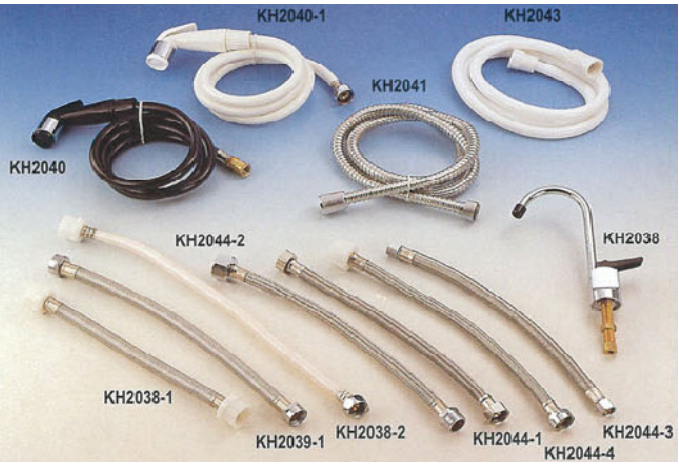



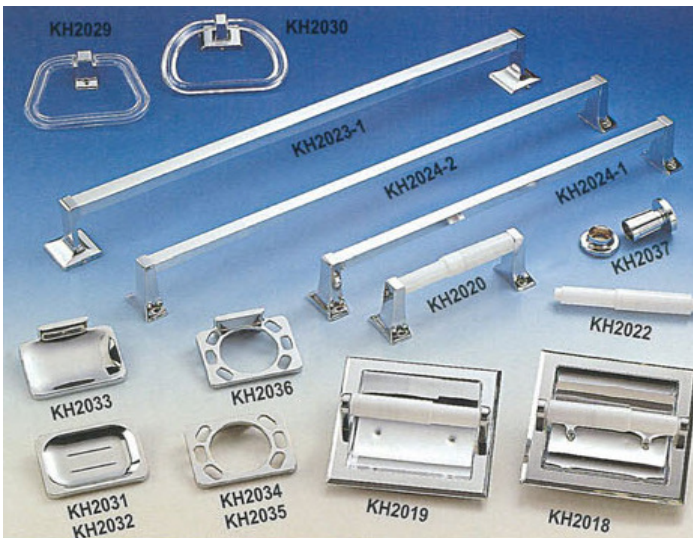
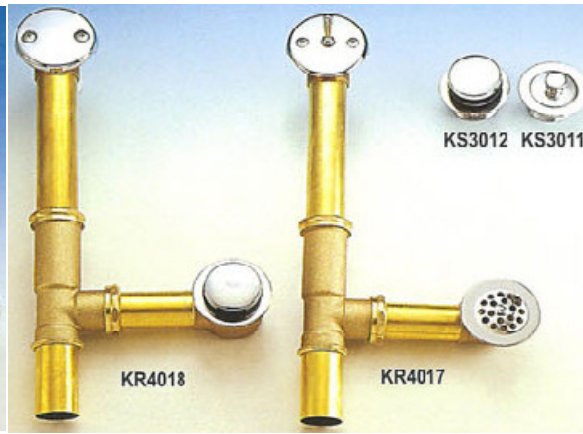
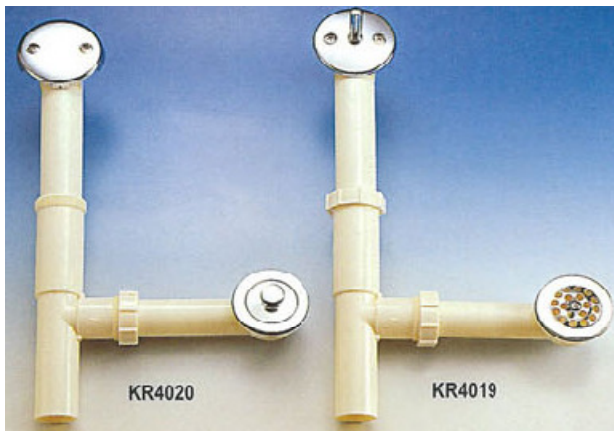

**KH2027**  
**KH2028**





**YZ41046 YZ41047 YZ41048 YZ41049 YZ41050 YZ41051**



**YZ41052 YZ41053 YZ51054 YZ51055 YZ51056 YZ51057**



**YZ41058 YZ41059 YZ41060 YZ41061 YZ41062 YZ41063**



**YZ42001 YZ42002 YZ42003 YZ42004 YZ42005 YZ42006**



**YZ42007 YZ42008 YZ42009 YZ42011 YZ42011 YZ42012**





**YZ41016**                      **YZ41017**                      **YZ41018**                      **YZ41019**



**YZ41021**



**YZ41022**



**YZ41023**



**YZ41024**



**YZ41025**



**YZ41031**



**YZ41032**



**YZ41033**



**YZ41034**



**YZ41035**



**YZ41036**



**YZ41037**



**YZ41038**



**YZ41039**



**YZ41040**



**YZ41041**



**YZ41042**



**YZ41043**



**YZ41044**



**YZ41045**



**YZ42013**



**YZ42014**



**YZ42015**



**YZ42016**



**YZ44011**

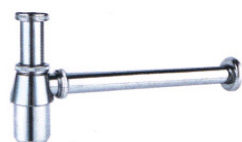

**YZ44012**



**YZ44013**



**YZ44014**



**YZ44015**



**YZ44016**



**YZ44017**



**YZ44018**



**YZ44019**



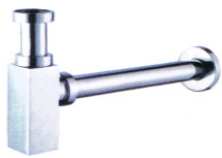

**YZ44020**

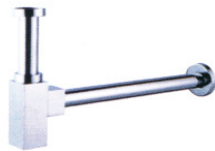

**YZ44021**

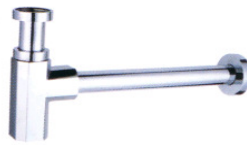

**YZ44022**



**YZ44023**



**YZ44024**



**YZ44025**



**YZ44026**



**YZ44027**

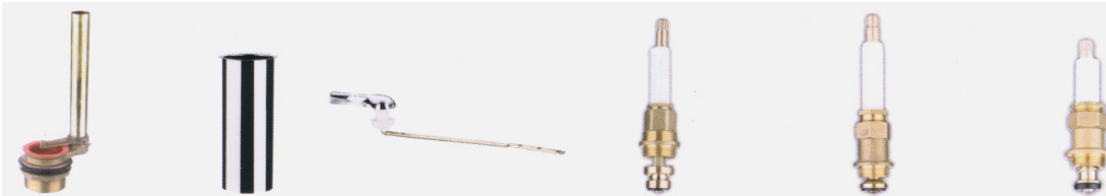

**YZ44009**

**YZ44010**

**YZ99901**

**YZ902001**

**YZ902002**

**YZ902003**



**YZ902004**



**YZ902005**



**YZ90226**



**YZ902007**



**YZ902008**



**YZ902009**



**YZ902010**



**YZ902011**



**YZ904001**



**YZ904002**



**YZ904003**



**YZ904004**

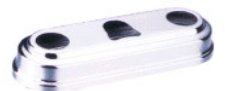

**YZ904005**



**YZ904006**



**YZ904007**



**YZ904008**



**YZ904009**

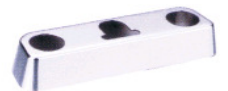

**YZ904010**



**YZ904011**



**YZ904012**



**YZ904013**



**YZ904014**



**YZ904015**



**YZ904016**



**YZ904017**



**YZ904018**



**YZ904019**



**YZ904020**

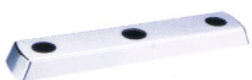

**YZ904021**



**YZ904022**



**YZ99903**



**YZ99903**



**YZ905001    YZ905002    YZ905003    YZ905004    YZ905005    YZ905006**



**YZ905007    YZ905008    YZ905009    YZ905010    YZ905011**



**YZ905012    YZ905013    YZ905014    YZ905015**



**YZ905016    YZ905017    YZ905018    YZ905019**



**YZ905020    YZ905021    YZ905022    YZ905023**

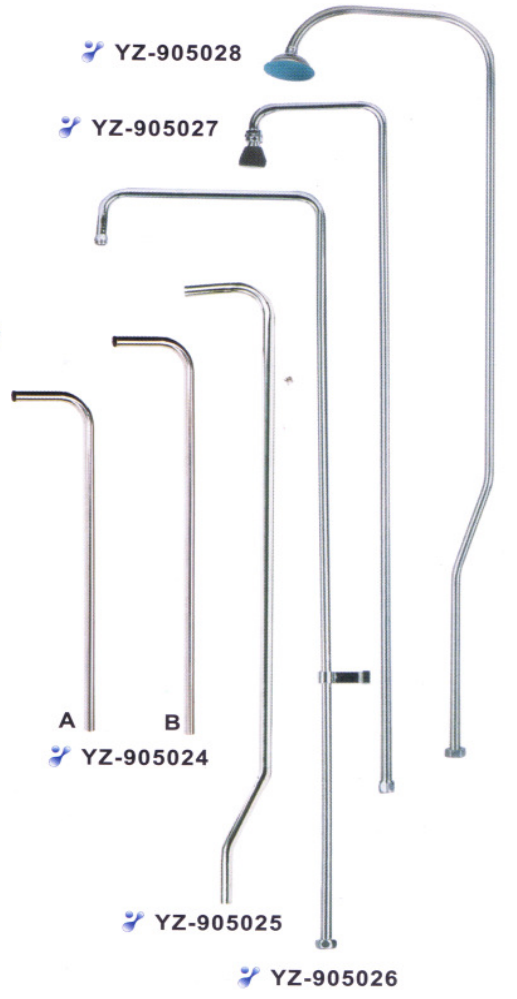

**YZ-905028**

**YZ-905027**

**A    B**  
**YZ-905024**

**YZ-905025**

**YZ-905026**



Phone: +49 / 4 21 - 5 37 97 -3  
Fax: +49 / 4 21 - 5 37 97 -55  
e-mail: brandes@pahco.de

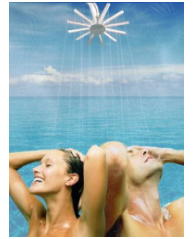

## **COLUNAS DE HIDROMASSAGEM**

**material: aço inoxidável, vidro, PVC, alumínio, madeira, bambu, latão, etc.**  
**chuveiro/ducha manual de latão ou ABS plástico cromado**

YLS 201



YLS 201A



YLS 202





**YLS 503**



**YLS 718**



**YLS 727**



**YLS 722B**



**YLS 728**



**YLS 729**



YLS 730



YLS 732



YLS 739



YLS 736



YLS 750





YLS 737



YLS 738CT



YLS 733BCT



YLS 733CT

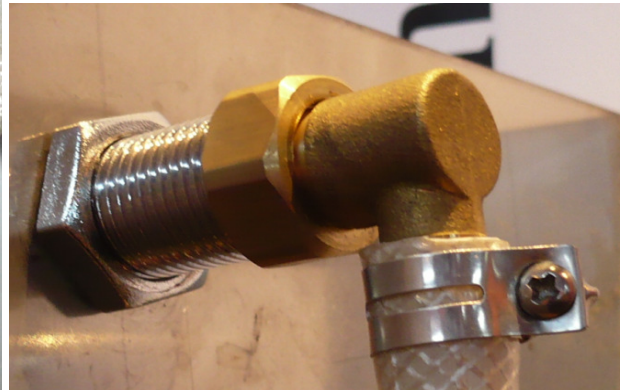



# **STAINLESS STELL SERIES**



## **ST-8831**

Features:

- \* material: stainless steel
- \* 4 way divert: top shower; hand shower; massage jets; spout
- \* size: 150\*17.5cm





**ST-8830**

Features:

- \* material: stainless steel
- \* 3 way divert: top shower; hand shower; massage jets
- \* size:140\*15cm



**ST-8828**

Features:

- \* material: stainless steel
- \* 3way divert: top shower; hand shower; massage jets
- \* size:140\*15cm



**ST-8827**

Features:

- \* material: stainless steel
- \* 4 way divert: top shower; hand shower; massage jets; spout
- \* size:160\*15cm



STAINLESS  
STELL  
SERIES



**ST-8829**

Features:

- \* material: stainless steel
- \* 3 way divert: top shower; hand shower; massage jets
- \* size: 160\*16cm



**ST-8838**

Features:

- \* material: stainless steel
- \* 3 way divert: top shower; hand shower; massage jets
- \* size: 145\*15cm





**ST-8835**

Features:

- \* material: stainless steel
- \* 3 way divert: top shower; hand shower; massage jets
- \* size: 157\*15cm

**ST-8832**

Features:

- \* material: stainless steel
- \* 3 way divert: top shower; hand shower; massage jets; spout
- \* size: 160\*16cm

**ST-8837**

Features:

- \* material: stainless steel
- \* 4 way divert: top shower; hand shower; massage jets; spout
- \* size: 150\*19.5cm





*STAINLESS  
STELL  
SERIES*



**ST-8839**

Features:  
\* material: stainless steel  
\* 3 way divert: top shower; hand shower; massage jets  
\* size:155\*19.5cm



**ST-8833**

Features:  
\* material: stainless steel  
\* 3 way divert: top shower; hand shower; massage jets  
\* size:150\*18cm



**ST-8836**

Features:  
\* material: stainless steel  
\* 3 way divert: top shower; hand shower; massage jets;spout  
\* size:160\*16cm

**ST-8825**

Features:

- \* material: stainless steel
- \* 3 way divert: top shower; hand shower; massage jets
- \* size: 140\*22cm

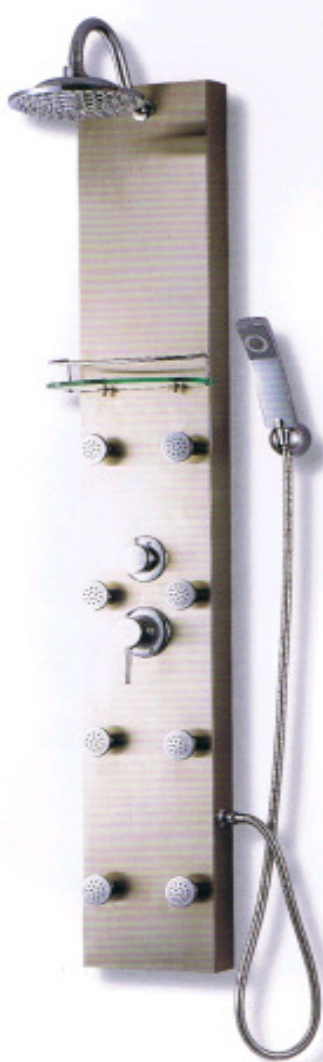
**ST-8801**

Features:

- \* material: stainless steel
- \* 3 way divert: top shower; hand shower; massage jets
- \* size: 155\*22cm

**ST-8809**

Features:

- \* material: stainless steel
- \* 3 way divert: top shower; hand shower; massage jets
- \* size: 140\*16cm





*STAINLESS  
STELL  
SERIES*



**ST-8802**

Features:

- \* material: stainless steel
- \* 3 way divert: top shower; hand shower; massage jets
- \* size: 142\*17cm

**ST-8803**

Features:

- \* material: stainless steel
- \* 4 way divert: top shower; hand shower; massage jets; spout
- \* size: 142\*35cm



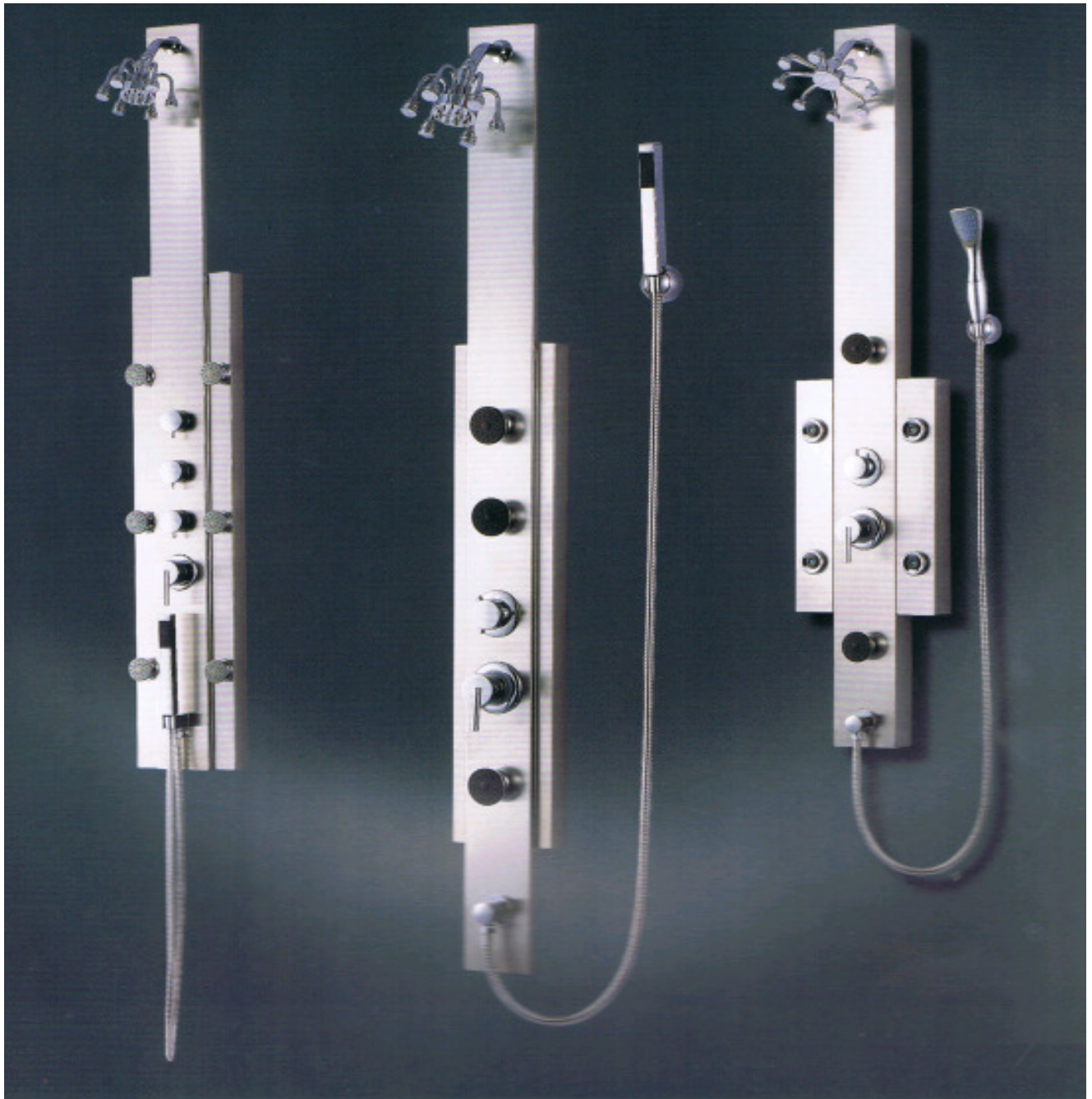

**ST-8822**

Features:

- \* material: stainless steel
- \* 3 way divert: top shower; hand shower; massage jets
- \* size: 150\*23cm

**ST-8821**

Features:

- \* material: stainless steel
- \* 3 way divert: top shower; hand shower; massage jets
- \* size: 150\*18cm

**ST-8810**

Features:

- \* material: stainless steel
- \* 3 way divert: top shower; hand shower; massage jets
- \* size: 142\*29cm



**ST-8805**

Features:  
 \* material: stainless steel  
 \* 3 way divert: top shower; hand shower; massage jets  
 \* size:146\*16cm



**ST-8811**

Features:  
 \* material: stainless steel  
 \* 3 way divert: top shower; hand shower; massage jets  
 \* size:188\*13cm



**ST-8808**

Features:  
 \* material: stainless steel  
 \* 3 way divert: top shower; hand shower; massage jets  
 \* size:175\*15cm



**ST-8807**

Features:  
 \* material: stainless steel  
 \* 3 way divert: top shower; hand shower; massage jets  
 \* size:150\*30cm





**ST-8823**

Features:

- \* material: stainless steel
- \* 3 way divert: top shower; hand shower; massage jets
- \* size: 163\*60cm



**ST-8806**

Features:

- \* material: stainless steel
- \* 3 way divert: top shower; hand shower; massage jets
- \* size: 133\*30cm



**ST-8826**

Features:

- \* material: stainless steel
- \* 3 way divert: top shower; hand shower; massage jets
- \* size: 156\*25cm





**ACABADOS SUMINISTRABLES - EN ACERO INOX**

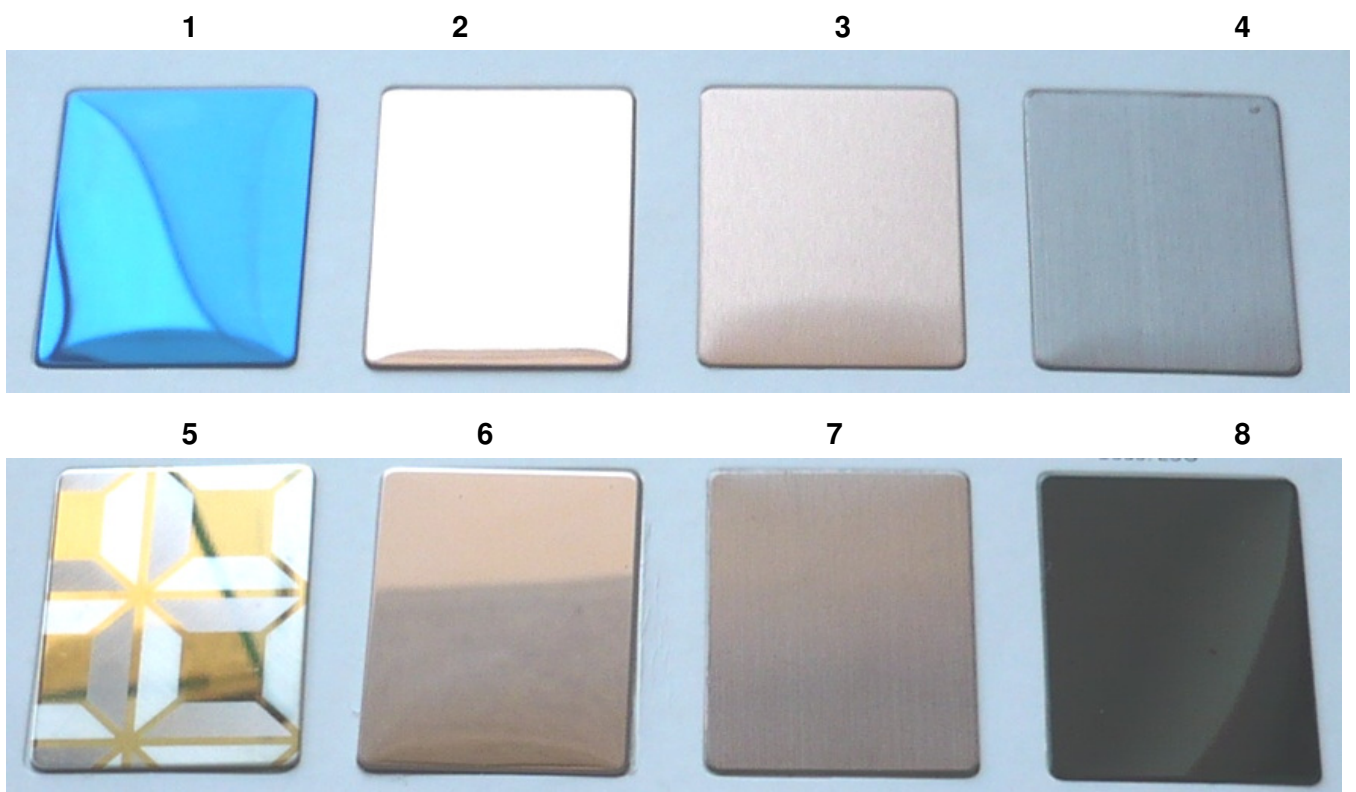

9

10

11

12

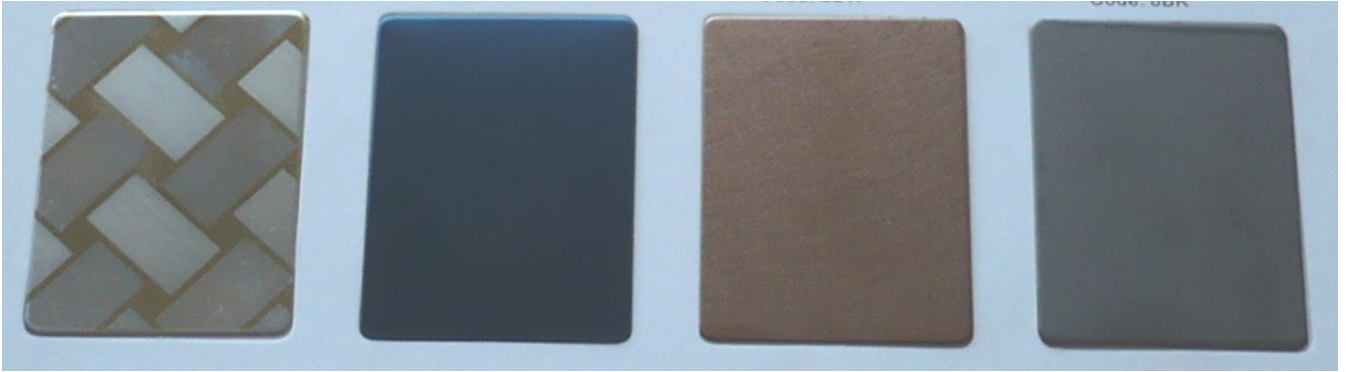

13

14

15

16

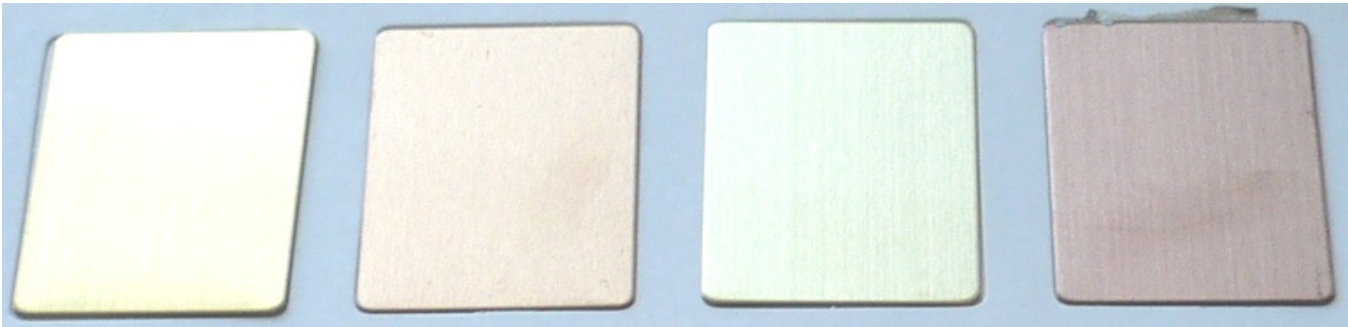

17

18

19

20

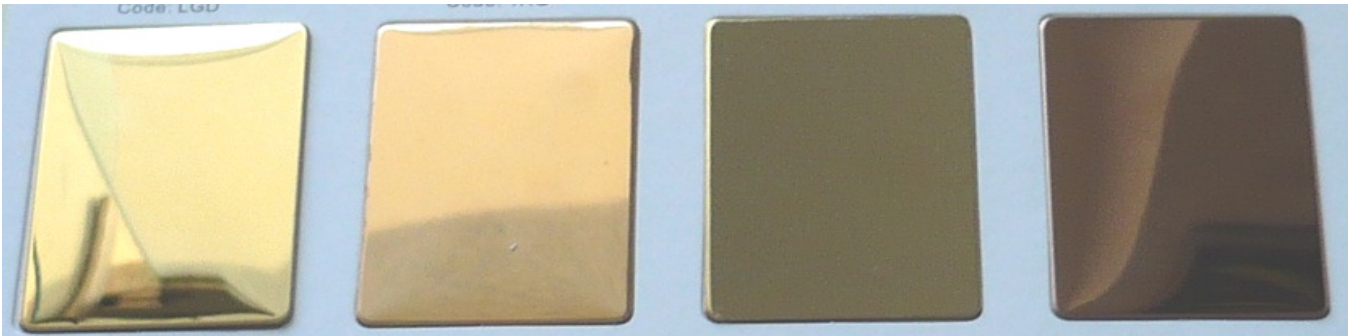

21

22

23

24

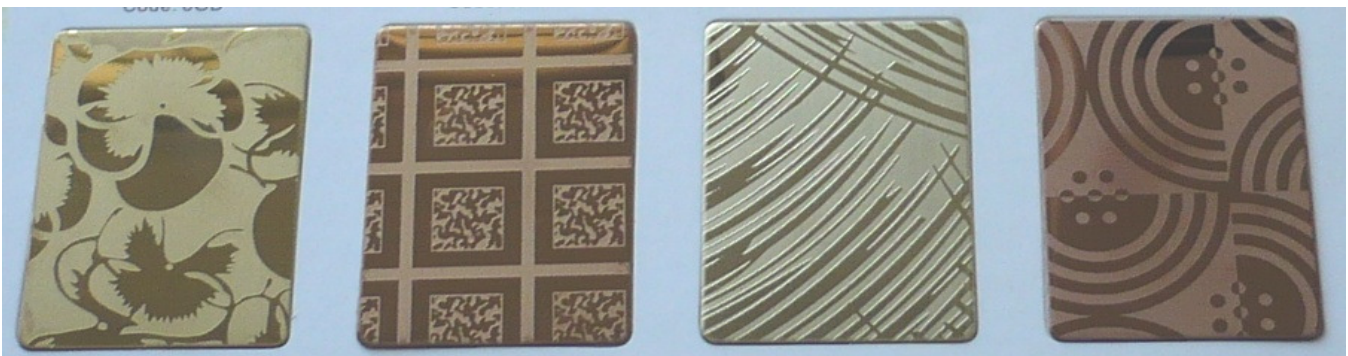



25



26



27



28



29



30



31



32



33



34

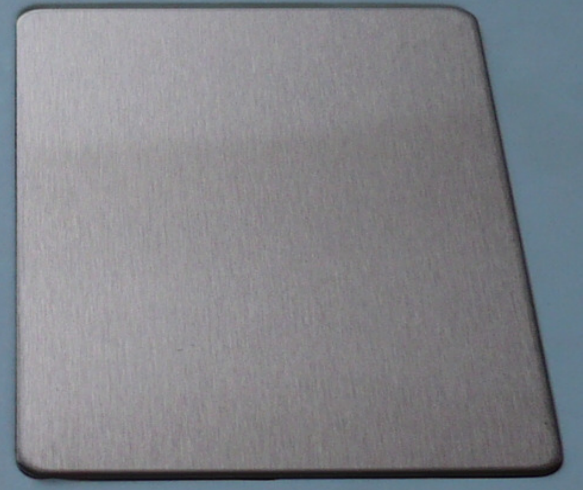

35



36





37



38



39



40



41





MATERIAL: VIDRO

# TEMPERED GLASS SERIES



## ST-8601-A

Features:

- \* material: glass and pvc
- \* 4 way divert: top shower; hand shower; massage jets; spout
- \* size: 172\*17cm



**ST-8601-B**

- Features:
- \* material: glass and pvc
  - \* 4 way divert: top shower; hand shower; massage jets; spout
  - \* size: 182\*17cm



**ST-8601-C**

- Features:
- \* material: glass and pvc
  - \* 3 way divert: top shower; hand shower; massage jets
  - \* size: 172\*17cm



**ST-8602-A**

- Features:
- \* material: glass and pvc
  - \* 3 way divert: top shower; hand shower; massage jets
  - \* size: 172\*17cm





**ST-8605-A**

Features:

- \* material: glass and stainless steel
- \* 3 way divert: top shower; hand shower; massage jets
- \* size: 150\*24cm



**ST-8603**

Features:

- \* material: glass and pvc
- \* 3 way divert: top shower; hand shower; massage jets
- \* size: 144\*17cm

TEMPERED  
GLASS  
SERIES



**ST-8605-B**

Features:

- \* material: glass and stainless steel
- \* 3 way divert: top shower; hand shower; massage jets
- \* size: 150\*24cm



**ST-8607**

- Features:
- \* material: glass and stainless steel
  - \* 3 way divert: top shower; hand shower; massage jets
  - \* size: 145\*22cm



**ST-8606**

- Features:
- \* material: glass and stainless steel
  - \* 3 way divert: top shower; hand shower; massage jets
  - \* size: 155\*22cm



**ST-8602-B**

- Features:
- \* material: glass and pvc
  - \* 3 way divert: top shower; hand shower; massage jets
  - \* size: 172\*17cm



# glass and stainless steel



■  
ST-8611  
Material: glass and  
stainless steel  
Size: 1450\*210mm



■  
ST-8612  
Material: glass and  
stainless steel  
Size: 1500\*200mm



■  
ST-8613  
Material: glass and  
stainless steel  
Size: 2250\*240mm





# **PVC**

## **SERIES**

### **ST-8901**

Features:

- \* material: pvc
- \* 4 way divert: top shower; hand shower; massage jets; spout
- \* size: 170\*15cm

# PVC SERIES



## ST-8902

Features:

- \* material: pvc
- \* 3 way divert: top shower; hand shower; massage jets
- \* size: 170\*15cm



## ST-8908

Features:

- \* material: pvc
- \* 4 way divert: top shower; hand shower; massage jets; spout
- \* size: 145\*23cm



## ST-8907

Features:

- \* material: pvc
- \* 3 way divert: top shower; hand shower; massage jets
- \* size: 150\*23cm



**ST-8911**

Features:  
\* material: pvc  
\* 3 way divert: top  
shower; hand shower;  
massage jets  
\* size:150\*28cm



**ST-8910**

Features:  
\* material: pvc  
\* 3 way divert: top  
shower; hand shower;  
massage jets  
\* size:150\*25cm



# PVC SERIES



## ST-8905

Features:  
\* material: pvc  
\* 3 way divert: top  
shower: hand shower;  
massage jets  
\* size: 125\*18cm



## ST-8909

Features:  
\* material: pvc  
\* 3 way divert: top  
shower: hand shower;  
massage jets  
\* size: 150\*25cm



## ST-8906

Features:  
\* material: pvc  
\* 3 way divert: top  
shower: hand shower;  
massage jets  
\* size: 156\*25cm



**ST-8903**

Features:  
\* material: pvc  
\* 3 way divert: top shower; hand shower; massage jets  
\* size:150\*18cm



**ST-8913**

Features:  
\* material: pvc  
\* 3 way divert: top shower; hand shower; massage jets  
\* size:100\*28cm



**ST-8912**

Features:  
\* material: pvc  
\* 3-ways divert: top shower; hand shower; massage jets  
\* size:100\*28cm



*PVC SERIES*



# WOOD SERIES

## ST-8301

- Features:  
 \* material: wood  
 \* 4 way divert: top shower; hand shower; massage jets; spout  
 \* size: 150\*25cm



## ST-8302

- Features:  
 \* material: wood  
 \* 3 way divert: top shower; hand shower; massage jets  
 \* size: 190cm



ST-8303  
 Material: wood  
 Size: 1900\*280mm

## YLY-5051 - madeira TEAK





**MATERIAL: BAMBU**

7908



7908A



**MATERIAL: LATÃO CROMADO**

YLS-1030



YLS-1031CT



YLS-1033

YLS-1035





YLS-1037CT



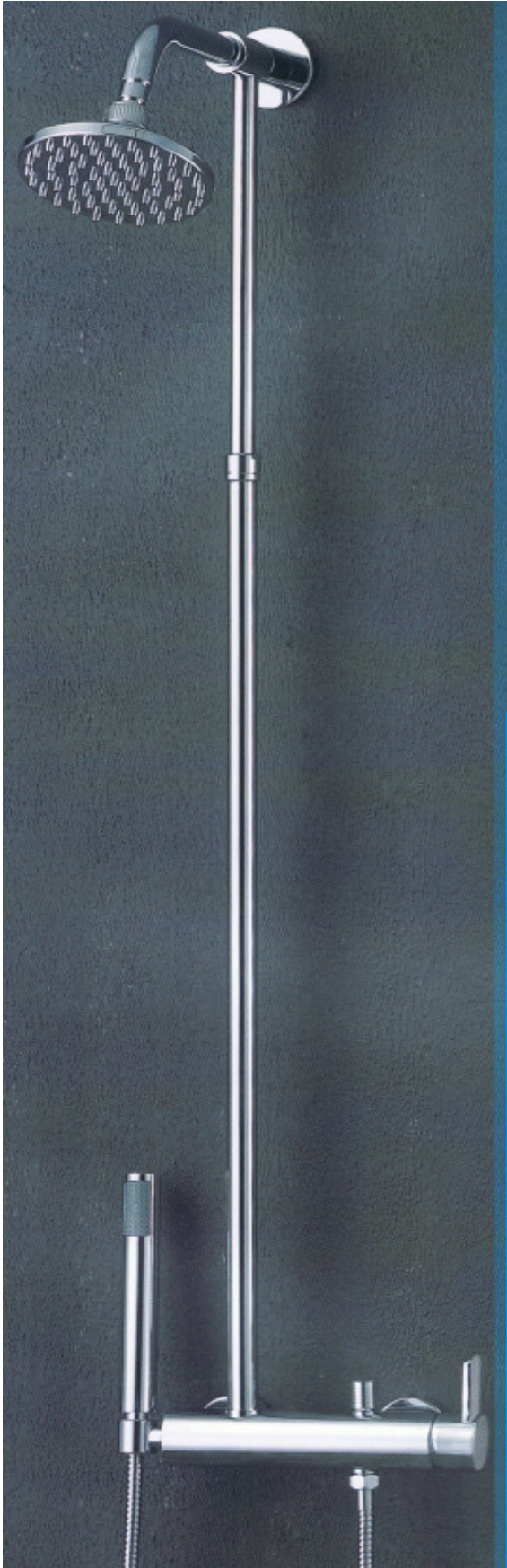

KTL880551-YL



□ KTL-RQ0251



□ KTL-RQ0351



□ KTL-RQ0331



□ KTL8506



□ KTL881951-8507



□ KTL880852E-8508





□ KTL-RQ0152



□ KTL-RQ0231



□ KTL-RQ0251A



□ KTL871351



□ KTL8504



□ KTL8505



62472  
Polished chrome  
Wall-mounted shower combination  
Batteria doccia incasso



62371  
Polished chrome  
Wall-mounted shower/sauna combination  
Batteria vasca incasso



62471  
Polished chrome  
Wall-mounted shower combination  
Batteria doccia incasso

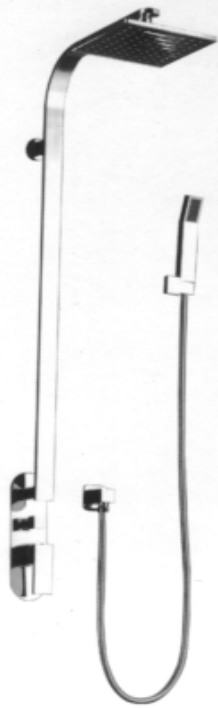

92101  
Polished Chrome  
rain shower combination  
colonna doccia completa di misce latore doccia  
doccetta e softione



92102  
Polished Chrome  
rain shower combination  
colonna doccia completa di misce latore doccia  
doccetta e softione

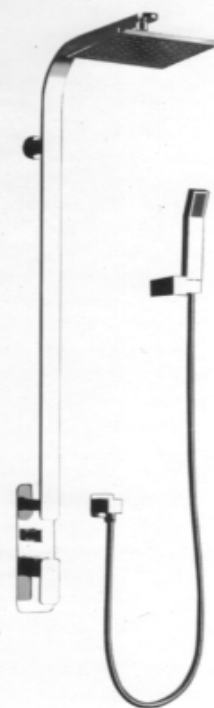

92103  
Polished Chrome  
rain shower combination  
colonna doccia completa di misce latore doccia  
doccetta e softione



92116  
Polished Chrome  
rain shower combination  
colonna doccia completa di misce latore doccia  
doccetta e softione



92112  
Polished Chrome  
rain shower combination  
colonna doccia completa di misce latore doccia  
doccetta e softione





**92104**  
Polished Chrome  
rain shower combination  
colonna doccia completa di misce latore doccia  
doccetta e softione



**92106**  
Polished Chrome  
rain shower combination  
colonna doccia completa di misce latore doccia  
doccetta e softione



**92105**  
Polished Chrome  
rain shower combination  
colonna doccia completa di misce latore doccia  
doccetta e softione



**92117**  
Polished Chrome  
rain shower combination  
colonna doccia completa di misce latore doccia  
doccetta e softione



**92113**  
Polished Chrome  
rain shower combination  
colonna doccia completa di misce latore doccia  
doccetta e softione



92107  
Polished Chrome  
rain shower combination  
colonna doccia completa di misce latore doccia  
doccetta e softione

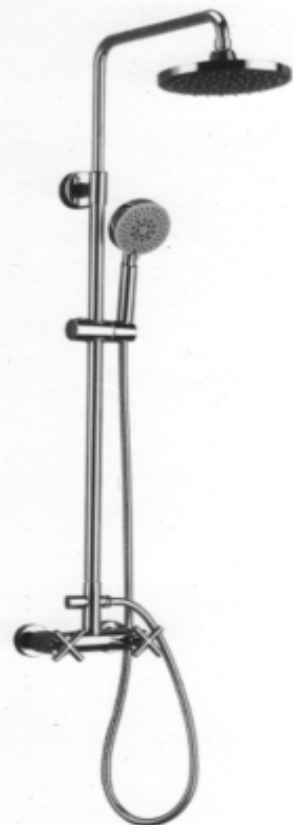

92109  
Polished Chrome  
rain shower combination  
colonna doccia completa di misce latore doccia  
doccetta e softione



92108  
Polished Chrome  
rain shower combination  
colonna doccia completa di misce latore doccia  
doccetta e softione



92110  
Polished Chrome  
rain shower combination  
colonna doccia completa di misce latore doccia  
doccetta e softione



92111  
Polished Chrome  
rain shower combination  
colonna doccia completa di misce latore doccia  
doccetta e soffione



10481  
Polished Chrome  
rain-shower combination  
plantana doccia da pavimento



92114  
Polished Chrome  
rain shower combination  
colonna doccia completa di misce latore doccia  
doccetta e soffione



92115  
Polished Chrome  
rain shower combination  
colonna doccia completa di misce latore doccia  
doccetta e soffione





**Brass Shower Set**  
**Model Number: X0001**



**Brass Shower Set**  
**Model Number: X0002**



**Brass Shower Set**  
**Model Number: X0003**



**Brass Shower Set**  
**Model Number: X0004**



**Brass Shower Set**  
**Model Number: X0005**



**Brass Shower Set**  
**Model Number: X0006**



**Brass Shower Set**  
**Model Number: X0007**



**Brass Shower Set**  
**Model Number: X0008**



**Brass Shower Set**  
**Model Number: X0009**

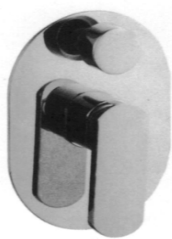

**33370**  
Polished Chrome  
concealed bath-shower mixer with diverter  
monocomando incasso per doccia  
con deviatore

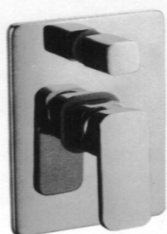

**25370**  
Polished Chrome  
concealed bath-shower mixer with diverter  
monocomando incasso per doccia  
con deviatore

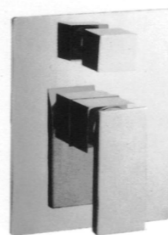

**35370**  
Polished Chrome  
concealed bath-shower mixer with diverter  
monocomando incasso per doccia  
con deviatore

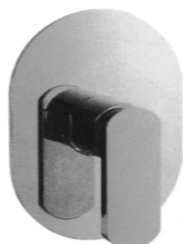

**33470**  
Polished Chrome  
concealed shower mixer  
monomando ducha de empotra

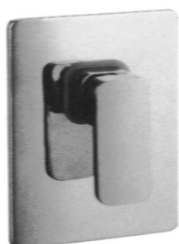

**25470**  
Polished Chrome  
concealed shower mixer  
monomando ducha de empotra

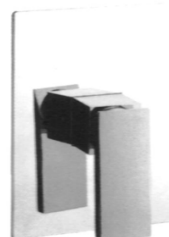

**35470**  
Polished Chrome  
concealed shower mixer  
monomando ducha de empotra

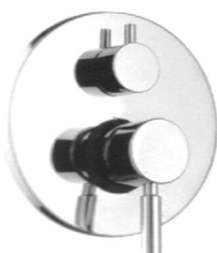

**10370**  
Polished Chrome  
concealed bath-shower mixer with diverter  
monocomando incasso per doccia  
con deviatore

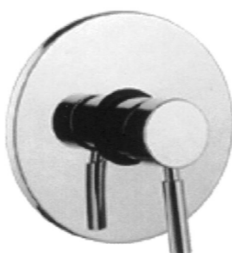

**10470**  
Polished Chrome  
concealed shower mixer  
monomando ducha de empotra



**01470**  
Polished Chrome  
concealed shower mixer  
monomando ducha de empotra



**91101**  
Polished Chrome  
wall-mounted brass shower set  
rociador ducha de empotra



**91102**  
Polished Chrome  
wall-mounted brass shower set  
rociador ducha de empotra





**92101**  
Polished Chrome  
wall-mounted brass shower set  
rociador ducha de empotra

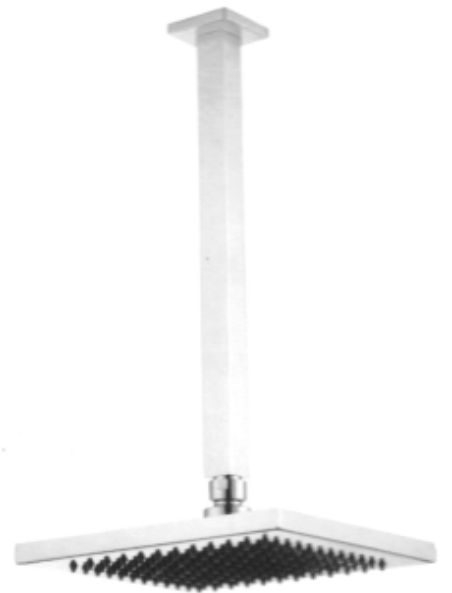

**92102**  
Polished Chrome  
wall-mounted brass shower set  
rociador ducha de empotra



Phone: +49 / 4 21 - 5 37 97 -3  
 Fax: +49 / 4 21 - 5 37 97 -55  
 e-mail: brandes@pahco.de



# CHUVEIROS DE LATÃO CROMADO

material: latão cromado, ABS plástico cromado, etc.  
 barras, braços e mangueiras

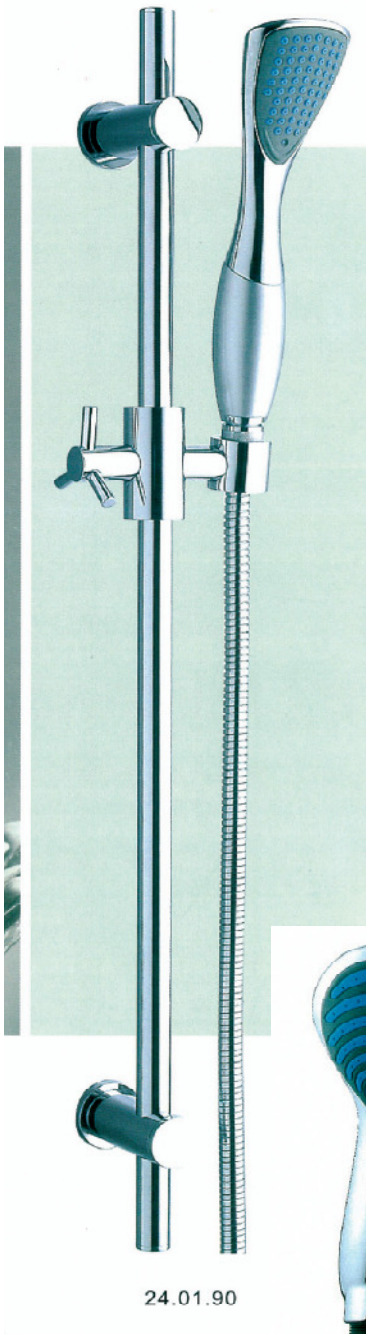

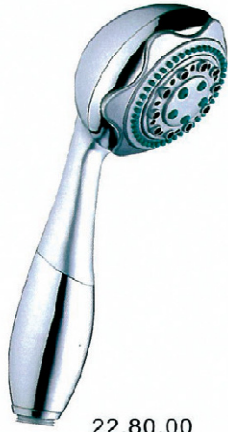

22.80.00



22.89.00



22.95.00



22.81.00



22.76.00



22.96.00



22.85.00



22.85.01

22.85.50



22.71.00



22.72.00



22.73.00







22.70.00



22.26.00



22.26.01



22.26.02



22.59.00

22.59.50



22.58.00

22.58.50



22.57.00

22.57.50



22.39.00



22.38.00



22.44.00





22.46.00



22.46.01



22.46.50



22.42.00



22.42.01



22.42.50



22.52.00



22.52.01



22.55.01

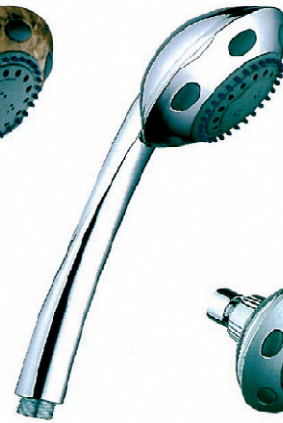

22.55.00



22.55.50



22.51.00



22.51.50



22.54.00



22.54.50



22.56.00



22.41.00



22.40.00



22.49.00



22.45.00



22.45.50





22.09.00



22.65.00 22.65.50



22.64.00 22.64.50



22.53.00 22.53.50



22.82.00 22.82.50



22.60.00 22.60.50



22.78.00 22.78.50



22.79.00 22.79.50



22.48.00



22.48.01



22.48.50



22.47.00



22.47.01



22.47.50



22.83.00



22.98.00



22.07.00



22.50.00







22.35.00



22.33.00



22.34.00



22.61.01 22.61.50



22.28.00



22.43.00



22.30.00



22.99.00



22.87.00

22.87.50



22.62.00



22.101.00



22.61.00



22.97.00





22.12.00



22.11.00



22.86.00



22.88.00



22.66.00



22.67.00



22.36.00



22.63.00



22.84.00



22.94.00



22.01.00



22.02.00



22.02.50



22.05.00







22.68.00



22.68.01



22.69.00



22.69.01



22.32.00



22.31.00

22.31.50



22.04.00



22.27.00

22.27.50



22.29.00

22.29.50



22.06.00







22.02.60



22.04.60

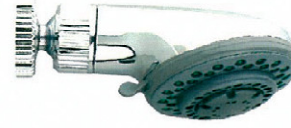

22.24.60



22.22.60

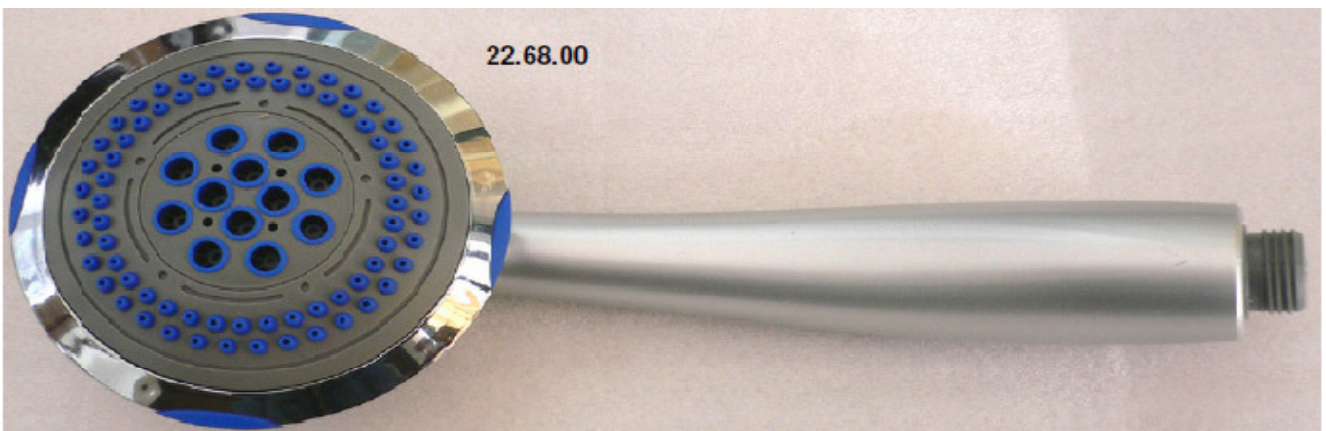

22.68.00



22.68.01



DW:C1075



DW:C1076



DW:C1077



DW:C1078



DW:C1079



DW:C1080



DW:C1081







= número de funções/posições















## JGOS. DUCHAS HIGIÊNICAS











22.103.00



22.104.00



22.25.00



DW:C1103



DW:C1104



DW:C1105



DW:C1106



DW:C1107



DW:C1108



DW:C1109



DW:C1110



## SOPORTES PARA DUCHAS HIGIÊNICAS / BIDET



JTK-01C



JTK-02W



JTK-03C



JTK-04B



JTK-04W



JTK-05C



JTK-06C

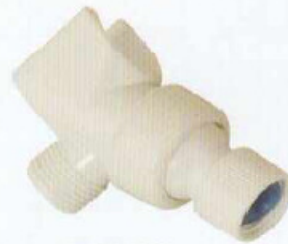

JTK-06W



JTK-07C



JTK-08C



JTK-09C



JTK-10C

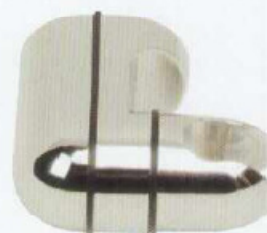

JTK-11C



JTK-12C



**JGOS. DE DUCHAS**  
**com chuveiro, barra, mangueira**

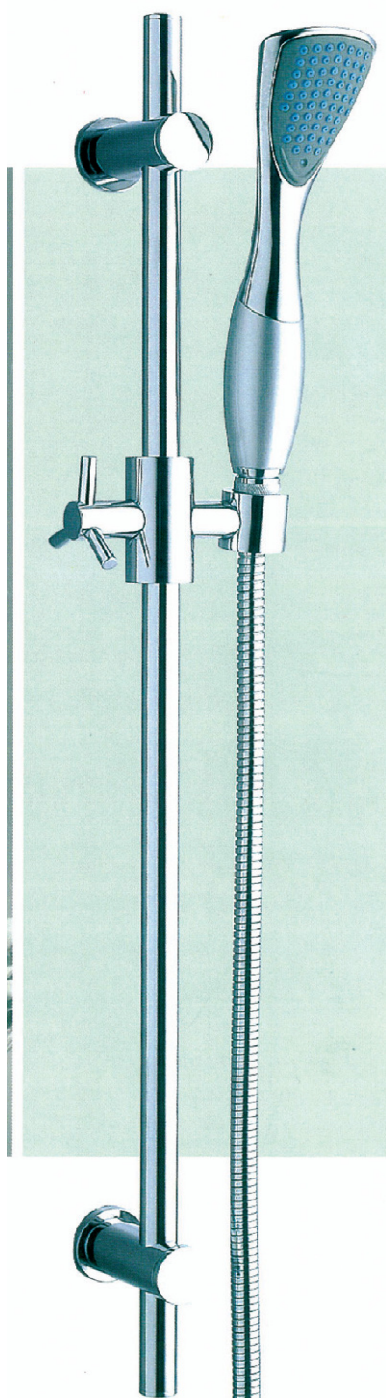

24.01.90



24.28.76



24.24.85



24.27.70

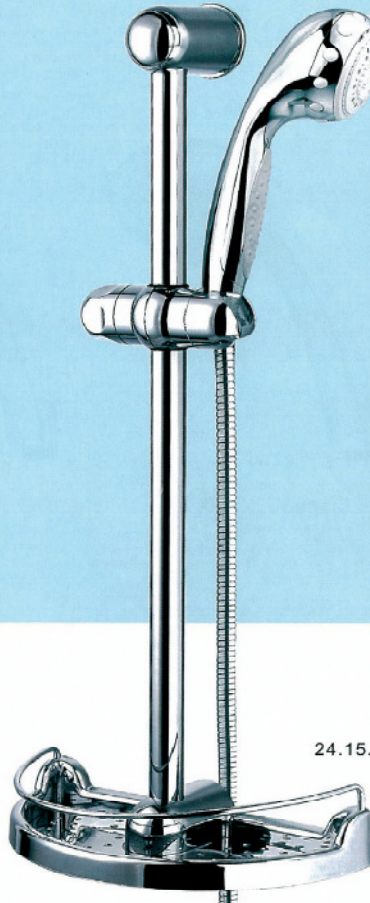

24.15.26



24.30.42







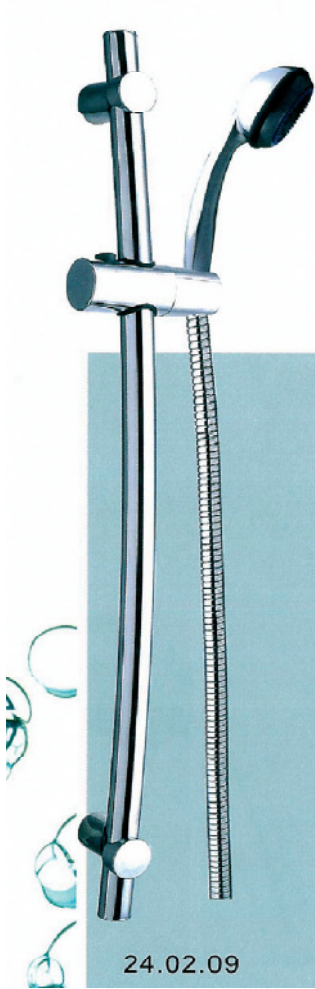

24.02.09



24.03.09



24.23.65

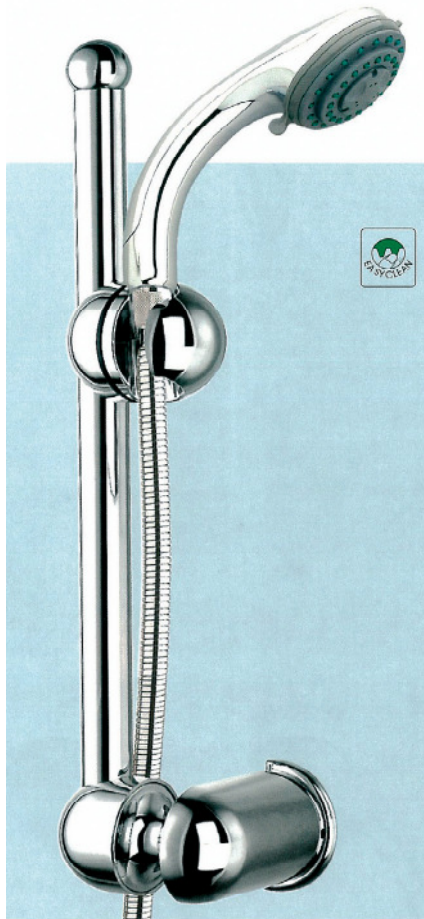

24.07.22



24.20.48





24.29.83



24.06.07



24.10.35



24.32.101





24.31.11



24.26.67



24.14.84



24.25.02



24.21.06



24.18.31





24.17.77



24.05.100



showerrail-set  
square type



2301 - latón!



2302



2303

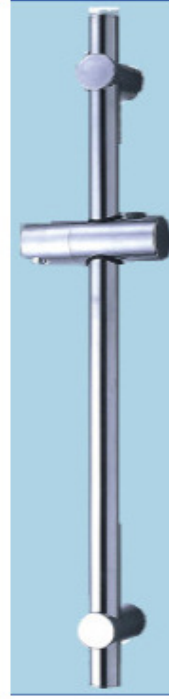

2308



2310



2318



2330



241777



242983



set-09



set-010



set-011



set-012





## MANGUEIRAS

material: latão, aço inoxidável, alumínio, PVC, etc.



**Y151**  
Extensible Flexible Hose  
Brass Double Lock



**Y152**  
Brass Beaded Hose

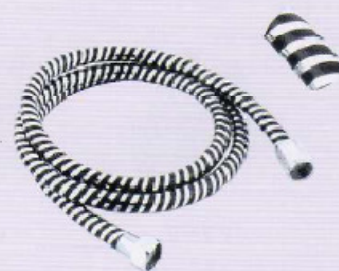

**Y153**  
PVC Spiralled Hose  
Black/Chrome



**Y154**  
PVC Reinforced Hose



**Y155**  
PVC Corrugate Hose  
Black/Chrome



**Y156**  
Flexible Hose Stainless  
Steel Single Lock



**Y157**  
Flexible Hose Stainless  
Steel Double Lock



**Y158**  
Flexible Hose Brass  
Single Lock



**Y159**  
Flexible Hose Brass  
Double Lock



**Y160**  
White PVC Corrugate Hose



**Y161**  
Extensible Flexible Hose  
Stainless Steel Double Lock



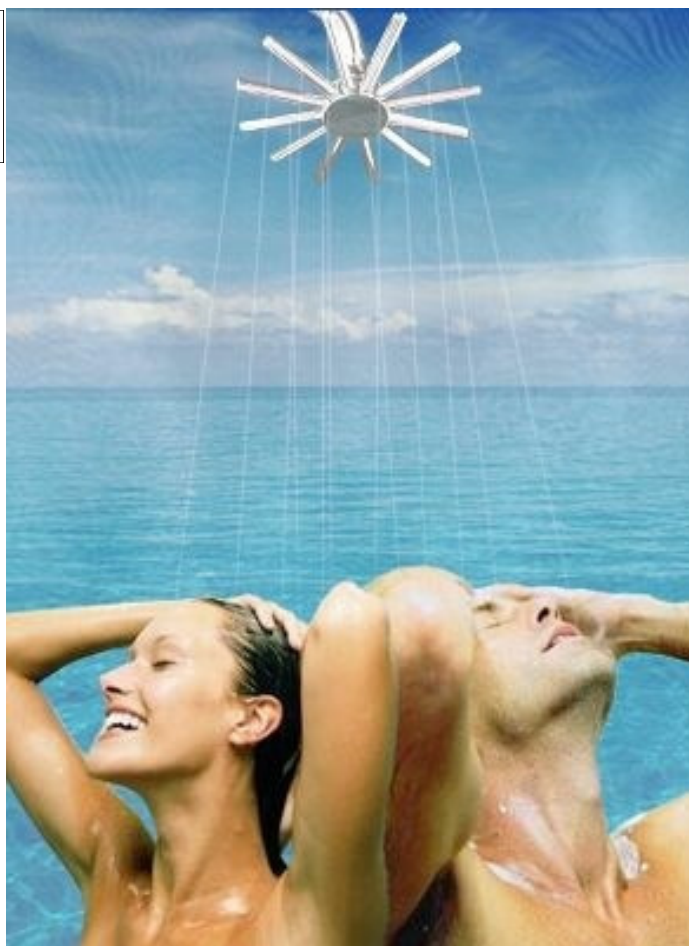

**PAHCO**

**A/502233-MAT**

## **CHUVEIROS - LANÇAMENTOS**

chuveiros teto, quadrado, redondo, duchas manuales, etc.  
barras e braços, desviadores, etc.

**Material: ABS plástico cromado - primeira qualidade  
e outros materiais**

**Filial No Brasil:**

***PAHCO do Brasil***

Rua 12 de Novembro, 180 - Centro, 3° A, Sala 31

CEP: 13465-490 Americana (SP) – Brasil

Tel.: (19) 3621 6070

Fax: (19) 3621 6073

[eliane.luis@pahco.de](mailto:eliane.luis@pahco.de)

[www.pahco.de](http://www.pahco.de)

**Matriz na Alemanha:**

***PAHCO GmbH***

Norderoog 1

28259 Bremen - Germany

Tel.: +49 / 421 – 5 37 97 – 3

Fax: +49 / 421 – 5 37 97 –55

[export@pahco.de](mailto:export@pahco.de)

[www.pahco.de](http://www.pahco.de)



Phone: +49 / 4 21 - 5 37 97 -3  
Fax: +49 / 4 21 - 5 37 97 -55  
e-mail: brandes@pahco.de



## **REGADERAS MODERNAS**

**Juegos de duchas, con barra y manguera, con jabonera, etc.  
Material: ABS plástico cromado**



## **CLASSIC ETERNAL FASHION**

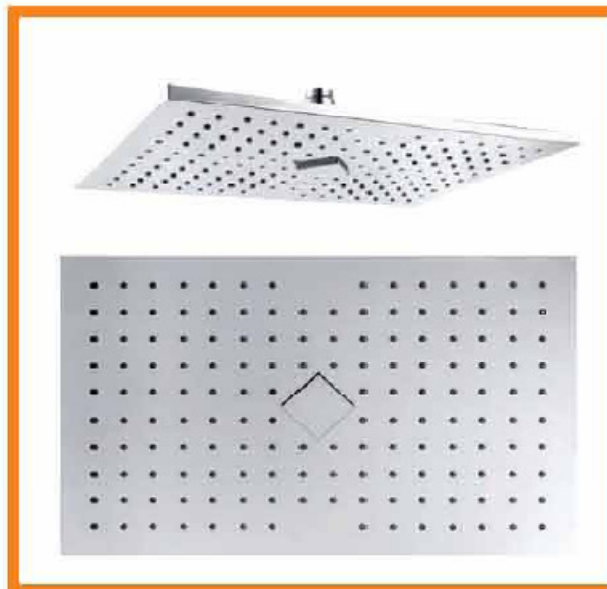

**model: S128**  
Designed by ECH 12"x8"



**model: S180**  
Designed by ECH 7"x7"

**COMBINATION OF  
SENSIBILITY AND  
RATIONALITY**



**model: BD108**  
Designed by ECH 10"x8"



**model: D320**  
Designed by ECH 8"



**model CD108**  
Designed by ECH 10"x8"



**model: 380**  
Designed by ECH 12"



**model: C面板**  
Designed by ECH



**model: 400**  
Designed by ECH 12"x12"

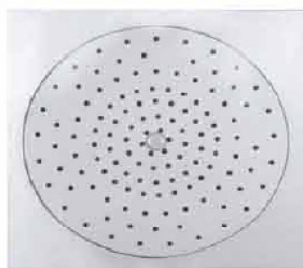

**model: B面板**  
Designed by ECH



**model: FD108**  
Designed by ECH 10"x8"

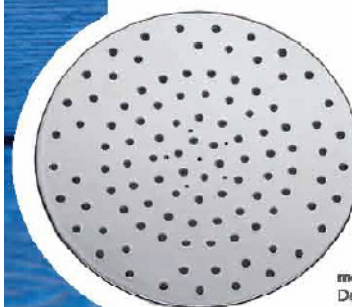

**model: D面板**  
Designed by ECH



# CLASSIC ETERNAL FASHION

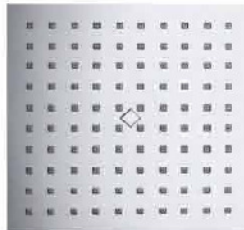
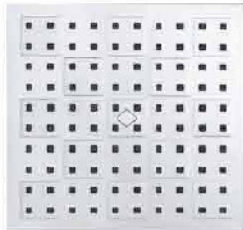
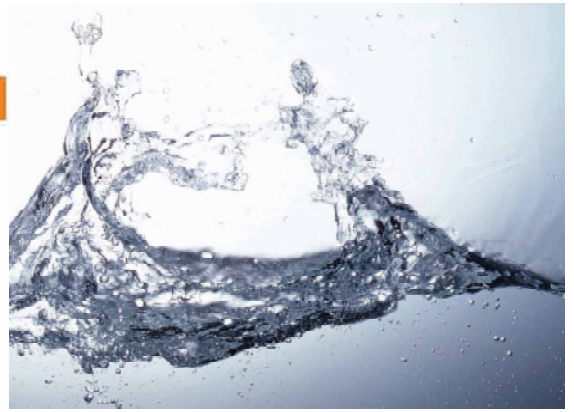

**model: GS200**  
Designed by ECH 8"x8"

**model: S200**  
Designed by ECH 8"x8"

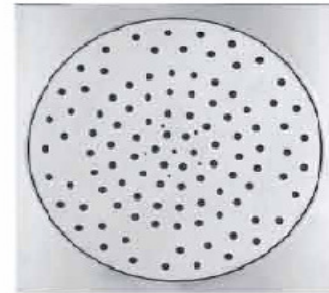

**model: D310**  
Designed by ECH 9"x9"

**model: S250**  
Designed by ECH 10"x10"

**model: SL250**  
Designed by ECH 10"x10"



**model: C300**  
Designed by ECH 9"

**model: B320**  
Designed by ECH 8"

**model: D280**  
Designed by ECH 9"



**model: D180**  
Designed by ECH 6"

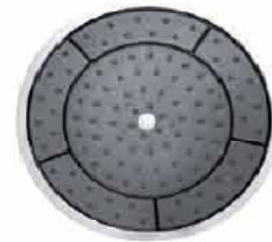
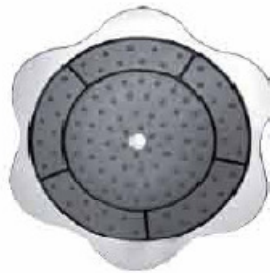

**model: D330**  
Designed by ECH 10"

**model: D330**  
Designed by ECH 10"

**model: D290**  
Designed by ECH 8"



**model: FD240**  
Designed by ECH 10"

**model: BD240**  
Designed by ECH 10"

**model: FD160**  
Designed by ECH 6"

**model: BD160**  
Designed by ECH 6"





**model: 300**  
Designed by ECH 8"



**model: B2201**  
Designed by ECH 9"



**model: 2201**  
Designed by ECH 9"



**model: B2202**  
Designed by ECH 6"



**model: 2202**  
Designed by ECH 6"



**model: B160**  
Designed by ECH 6"



**model: B240**  
Designed by ECH 10"





# FASHIONABLE SHAPE



**model: 27V1**  
Designed by ECH  
Single Function



**model: 27V2**  
Designed by ECH  
2 Functions



**model: 27V4**  
Designed by ECH  
4 Functions



**model: 27K1**  
Designed by ECH  
Single Function



**model: 27K2**  
Designed by ECH  
2 Functions



**model: 27K4**  
Designed by ECH  
4 Functions



**model: 27H4**  
Designed by ECH  
4 Functions



**model: 27H2**  
Designed by ECH  
2 Functions



**model: 27H1**  
Designed by ECH  
Single Function



# A GOOD DESIGN IS THE PERFECT COMBINATION OF



**model: 2731**  
Designed by ECH  
**Single Function**



**model: 2732**  
Designed by ECH  
**2 Functions**



**model: 2734**  
Designed by ECH  
**4 Functions**



**model: 27F1**  
Designed by ECH  
**Single Function**



**model: 27F2**  
Designed by ECH  
**2 Functions**



**model: 27F4**  
Designed by ECH  
**4 Functions**



**model: 27E4**  
Designed by ECH  
**4 Functions**



**model: 27E2**  
Designed by ECH  
**2 Functions**



**model: 27E1**  
Designed by ECH  
**Single Function**



**model: 27D4**  
Designed by ECH  
4 Functions



**model: 27D2**  
Designed by ECH  
2 Functions



**model: 27D1**  
Designed by ECH  
Single Function



**model: 27A4**  
Designed by ECH  
4 Functions



**model: 27A2**  
Designed by ECH  
2 Functions



**model: 27A1**  
Designed by ECH  
Single Function







**model: 2811**  
Designed by ECH  
Single Function



**model: 2800**  
Designed by ECH  
Single Function



**model: 2707**  
Designed by ECH  
Single Function



**model: 2709**  
Designed by ECH  
Single Function



**model: F2733**  
Designed by ECH  
Single Function



**model: B2733**  
Designed by ECH  
Single Function



**model: B2722**  
Designed by ECH  
Single Function



**model: 2655**  
Designed by ECH

## A GOOD DESIGN





**model: B27AD**  
Designed by ECH  
Single Function



**model: F27AD**  
Designed by ECH  
Single Function



**model: F2733**  
Designed by ECH  
Single Function



**model: B2733**  
Designed by ECH  
Single Function



**model: B2722**  
Designed by ECH  
Single Function



**model: 2755**  
Designed by ECH  
Single Function



**model: 2766**  
Designed by ECH  
Single Function



**model: T28F6**  
Designed by ECH  
3 Functions



**model: 28F6**  
Designed by ECH  
2 Functions



**model: S28F6**  
Designed by ECH  
Single Function



**model: S2787**  
Designed by ECH  
Single Function



**model: 2787**  
Designed by ECH  
2 Functions



**model: T2787**  
Designed by ECH  
3 Functions





**model: T2602**  
Designed by ECH  
3 Functions



**model: S2602**  
Designed by ECH  
Single Function



**model: 2602**  
Designed by ECH  
3 Functions



**model: 26A1**  
Designed by ECH  
Single Function



**model: 2616**  
Designed by ECH  
3 Functions



**model: T2615**  
Designed by ECH  
3 Functions



**model: 2615**  
Designed by ECH  
2 Functions



**model: S2615**  
Designed by ECH  
Single Function





**model: T2702**  
Designed by ECH  
3 Functions



**model: 2702**  
Designed by ECH  
2 Functions



**model: S2702**  
Designed by ECH  
Single Function



**model: T2712**  
Designed by ECH  
3 Functions



**model: 2712**  
Designed by ECH  
2 Functions



**model: S2712**  
Designed by ECH  
Single Function



**model: 27B1**  
Designed by ECH  
2 Functions



**model: S27B1**  
Designed by ECH  
Single Function



**model: T27B1**  
Designed by ECH  
3 Functions



**model: T2708**  
Designed by ECH  
3 Functions



**model: 2708**  
Designed by ECH  
2 Functions



**model: S2708**  
Designed by ECH  
Single Function



**model: 2662**  
Designed by ECH  
2 Functions



**model: 2672**  
Designed by ECH  
2 Functions



**model: 2652**  
Designed by ECH  
2 Functions



**model: 2688**  
Designed by ECH  
Single Function



**model: 2677**  
Designed by ECH  
Single Function



**model: 2655**  
Designed by ECH  
Single Function



**model: 2632**  
Designed by ECH  
2 Functions



**model: 2631**  
Designed by ECH  
Single Function



**model: T2606**  
Designed by ECH  
3 Functions





**model: 2502**  
Designed by ECH  
2 Functions



**model: C2502**  
Designed by ECH  
2 Functions



**model: 2512**  
Designed by ECH  
2 Functions



**model: 2752**  
Designed by ECH  
3 Functions



**model: A2737**  
Designed by ECH  
3 Functions



**model: 2715**  
Designed by ECH  
3 Functions



**model: 26A7**  
Designed by ECH  
2 Functions



**model: 2618**  
Designed by ECH  
2 Functions



**model: 2298**  
Designed by ECH  
4 Functions



**model: 2295**  
Designed by ECH  
3 Functions



**model: 23A5**  
Designed by ECH  
3 Functions



**model: B2110**  
Designed by ECH  
3 Functions

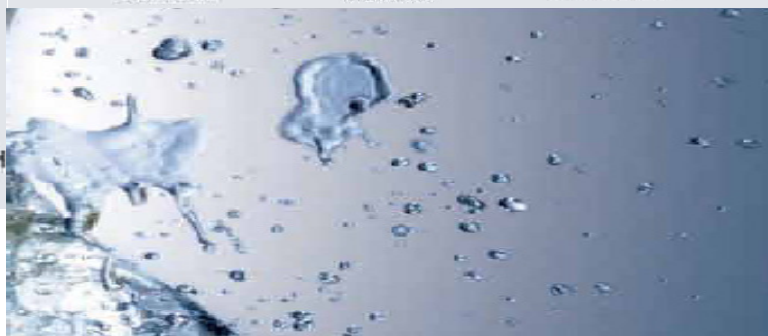

**model: 23B0**  
Designed by ECH  
3 Functions

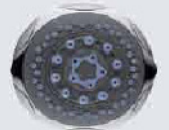

**model: 23A8**  
Designed by ECH  
4 Functions







**model: B2100**  
Designed by ECH



**model: S2100**  
Designed by ECH  
Single Function



**model: 2302**  
Designed by ECH  
2 Functions



**model: 2303**  
Designed by ECH  
2 Functions



**model: 2322**  
Designed by ECH  
Single Function



**model: 2304**  
Designed by ECH  
2 Functions



**model: K2305**  
Designed by ECH  
2 Functions



**model: 2366**  
Designed by ECH  
Single Function



# FASHIONABLE SHAPE



**model: 2377**  
Designed by ECH  
Single Function



**model: 2368**  
Designed by ECH  
Single Function



**model: 2313**  
Designed by ECH  
2 Functions



**model: 2312**  
Designed by ECH  
2 Functions



**model: 2508**  
Designed by ECH  
2 Functions



**model: 2002**  
Designed by ECH  
2 Functions



**model: 2200**  
Designed by ECH  
Single Function



**model: 2800**  
Designed by ECH  
Single Function



**model: 2811**  
Designed by ECH  
Single Function



**model: 2822**  
Designed by ECH  
Single Function



**model: 2611**  
Designed by ECH  
Single Function



**model: 2622**  
Designed by ECH  
Single Function



**model: 2633**  
Designed by ECH  
Single Function



**model: F2733**  
Designed by ECH  
Single Function



**model: B2480**  
Designed by ECH  
Single Function



**model: 2755**  
Designed by ECH  
Single Function



**model: B2722**  
Designed by ECH  
Single Function



**model: F2480**  
Designed by ECH  
Single Function



**model: 2766**  
Designed by ECH  
Single Function



**model: F2509**  
Designed by ECH  
Single Function



**model: R2509**  
Designed by ECH  
Single Function



**model: 2509**  
Designed by ECH  
Single Function



**model: 2707**  
Designed by ECH  
Single Function



**model: 2709**  
Designed by ECH  
Single Function

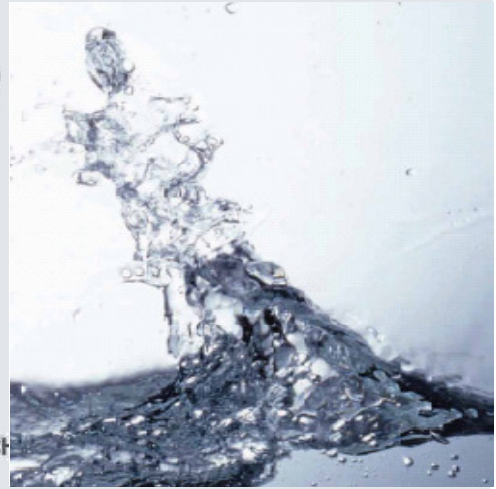

**model: 2300**  
Designed by ECH  
Single Function



**model: 2309**  
Designed by ECH  
Single Function



**model: 1305**  
Designed by ECH  
Single Function





model: 2500-C  
Designed by ECH  
Single Function



model: 2500-D  
Designed by ECH  
Single Function



model: 2500-B  
Designed by ECH  
Single Function



model: 2500-E  
Designed by ECH  
Single Function

## SHOWER SET SERIES

**DESIGNERS HAVE ENDOWED  
CONVENTIONAL PRODUCTS WITH  
NEW LIFE**



**model: 2734+MX22**  
Designed by ECH



**model: 27H4+MX22**  
Designed by ECH



**model: 27E2+FT**  
Designed by ECH



**model: 2733+FT**  
Designed by ECH



**model: 2722+MX22**  
Designed by ECH



**model: 27H4+FS**  
Designed by ECH



**model: MD22**  
Designed by ECH  
screw distance:60cm  
tube diameter:22mm



**model: MX22**  
Designed by ECH  
screw distance:60cm  
tube diameter:22mm



**model: IT**  
Screw distance: 80cm(58cm)



**model: IS**  
Screw distance: 80cm(58cm)



**model: ST**  
Screw distance: 61.5cm



**model: BK**  
Screw distance: 64.4cm/60cm



**model: S**  
Screw distance: 61.5cm



**model: MA Soap dish**



**model: GR Soap dish**





model: U  
Screw distance: 60cm



model: UV  
Screw distance: 58cm



model: V  
Screw distance: 60cm



model: VS  
Screw distance: 60cm



model: U Soap dish



model: Q Soap dish



model: E Soap dish



model: YA  
Screw distance: 60cm



model: VS+ED  
Screw distance: 80cm

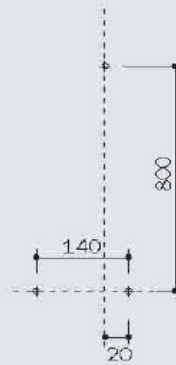

model: YA+ED  
Screw distance: 80cm



model: MA25+IC  
Screw distance: 60cm



model: MA19+D19  
Screw distance: 60cm



model: D19 Soap dish



model: IC Soap dish



model: BF Soap dish



model: FS  
Screw distance: 60cm



model: ET  
Screw distance: 60cm



model: FT  
Screw distance: 60cm



model: FU  
Screw distance: 60cm



model: EU  
Screw distance: 60cm

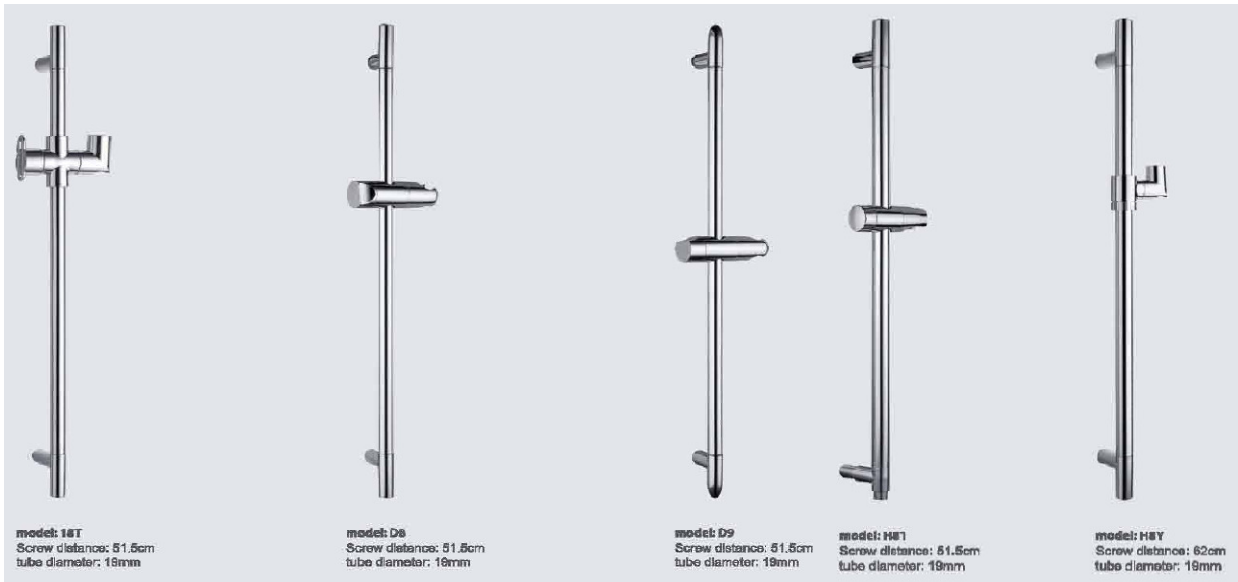





# FITTING SERIES

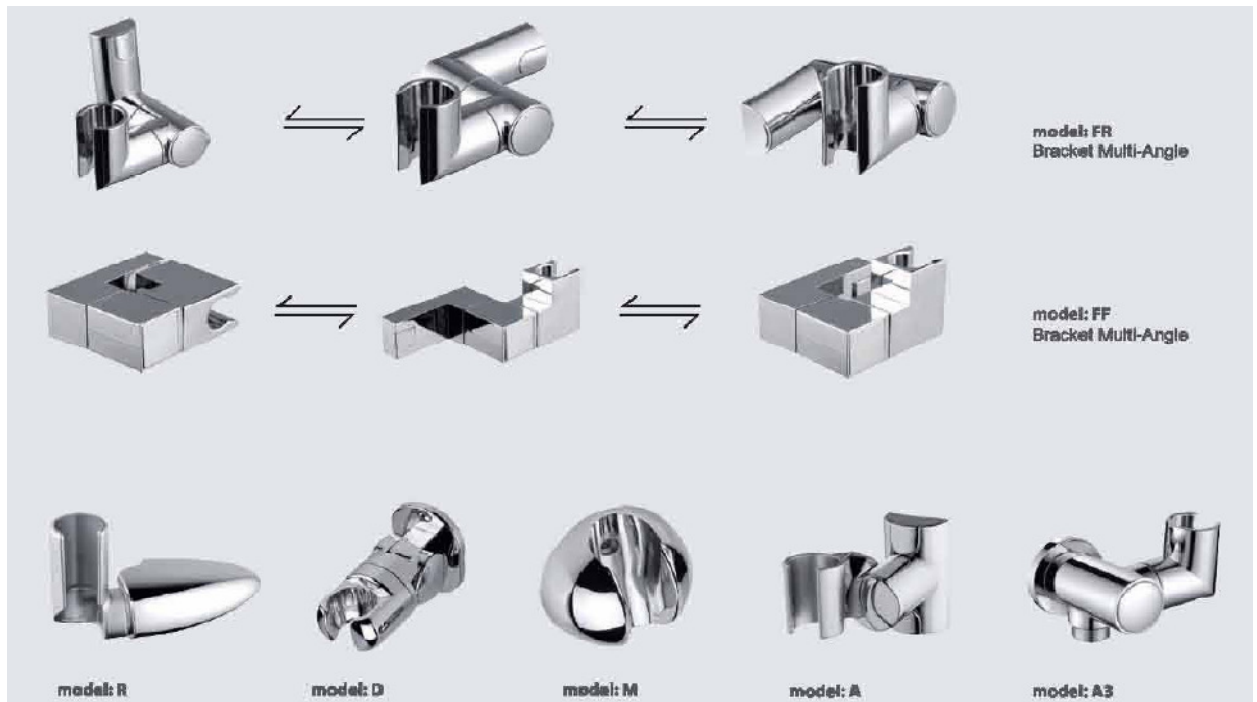

**model: D19 Soap dish**



**model: U Soap dish**



**model: O Soap dish**



**model: IC Soap dish**



**model: E Soap dish**



**model: BF Soap dish**



**model: SK Soap dish**



**model: GR Soap dish**



**model: GF Soap dish**



**model: MA Soap dish**



**model: 145 shower arm**



**model: L-150**



**model: Ø32 shower arm**



**model: SL400**



model: Jet A shower holder



model: Jet B



model: Shower connector



model: DL90



model: DL120



model: YGZ



model: FYGZ



model: DP1



model: RI1



model: FR01



model: FI1



model: H81



model: E shower holder(ø25)



model: A shower holder(ø25)



model: F shower holder(ø25)



model: D30 shower holder(ø30)



model: Q shower holder(ø25)



model: C shower holder(ø25)



model: Y shower holder(ø25)



model: D19 shower holder(ø19)



model: T shower holder(ø25)



model: P shower holder(ø25)





# CHUVEIROS DE LATÃO CROMADO

outros materiais: ABS plástico cromado, aço inoxidável

**225**

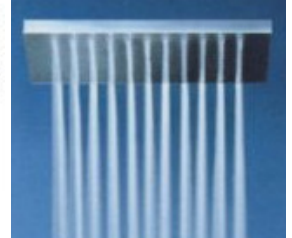
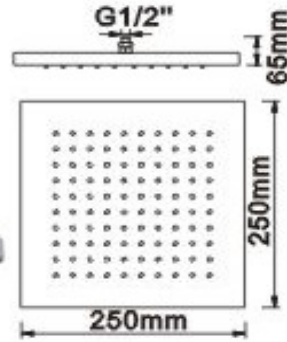

**3318**

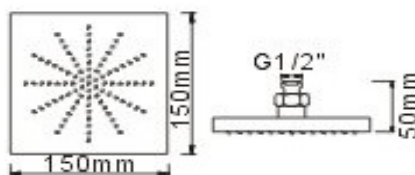
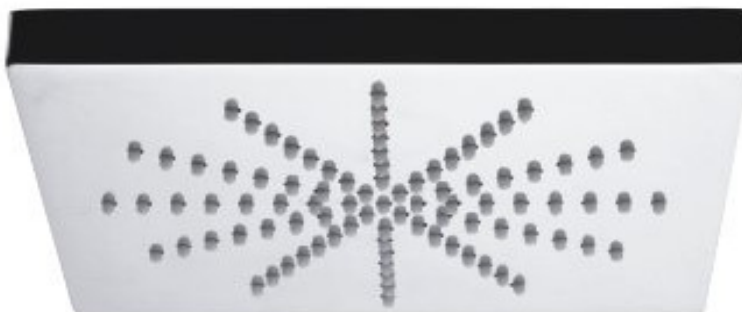
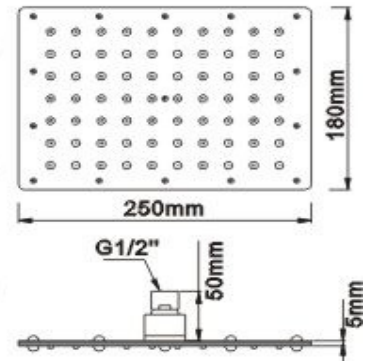
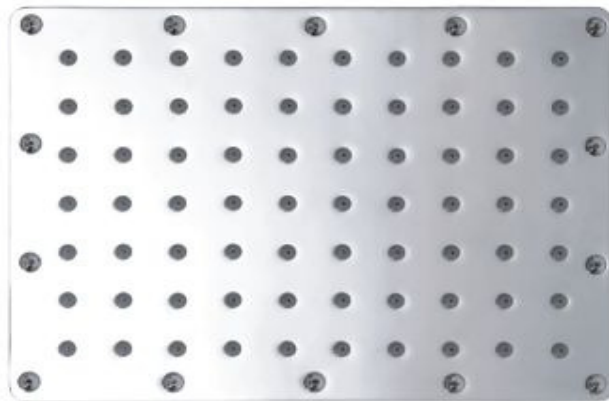

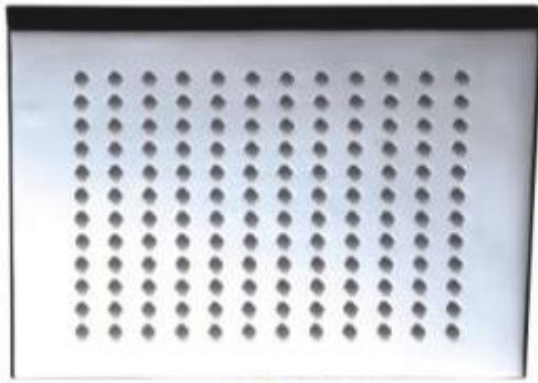

502

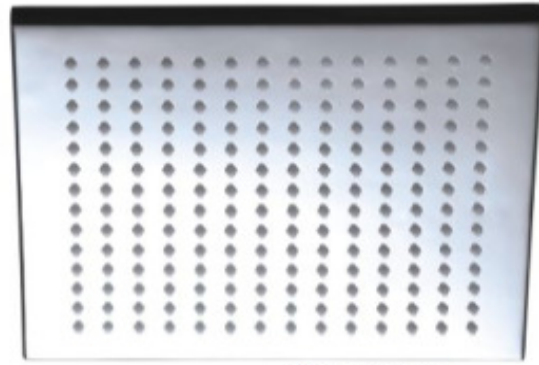
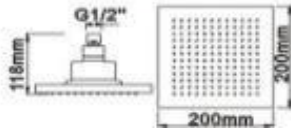

504

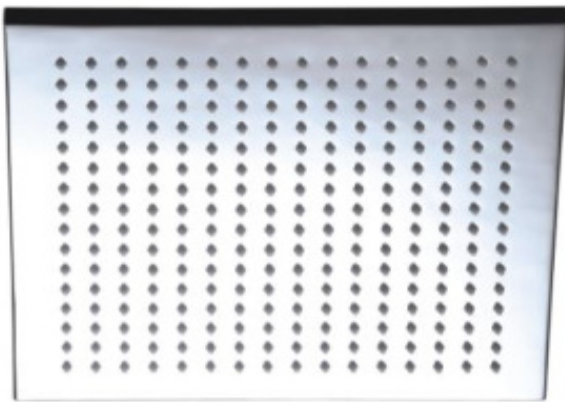
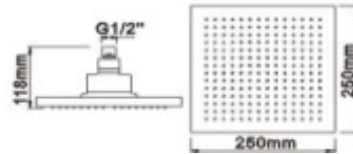

506

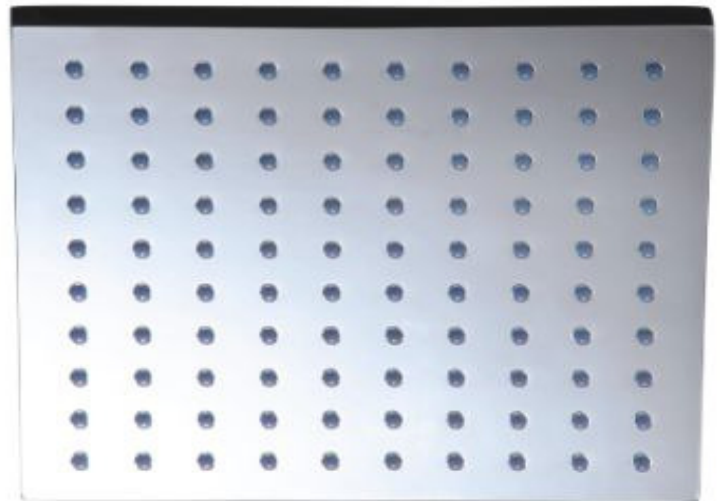
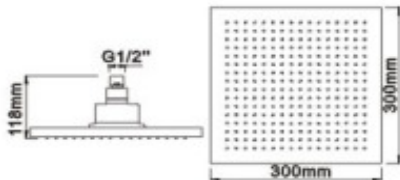

703

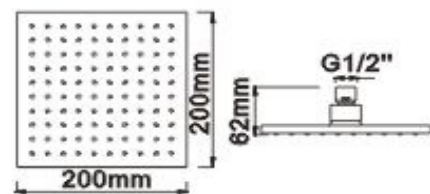



● **501**

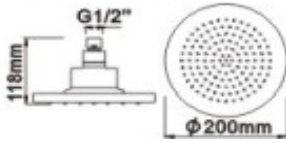

● **503**

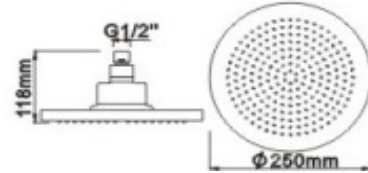

● **505**

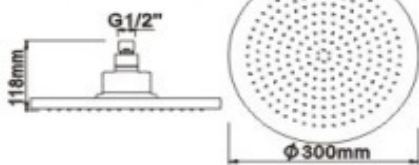

● **702**

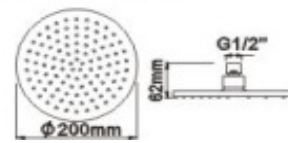



## CHUVEIROS COM ILUMINAÇÃO - LED

### 501L

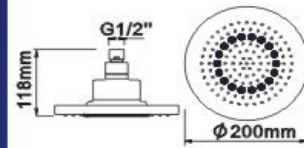

### 502L

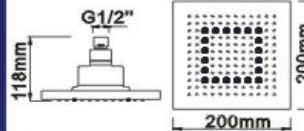

### 503L

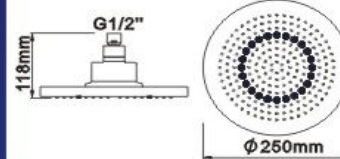

### 504L

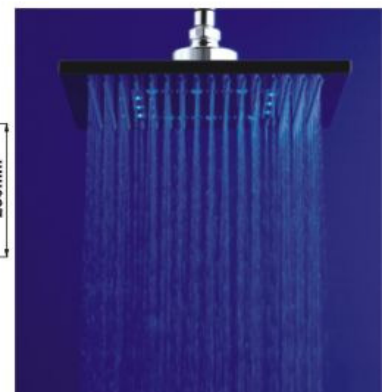
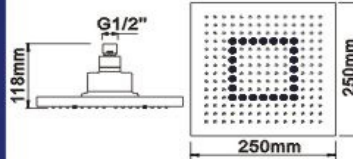

505L

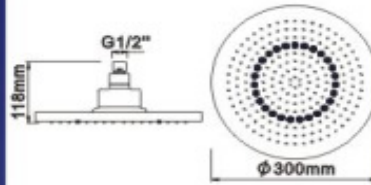

506L

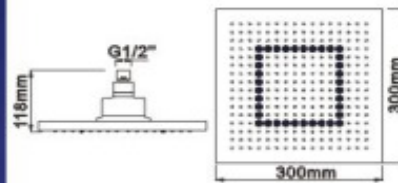

601L

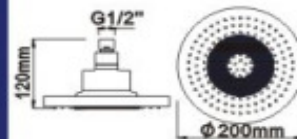

602L

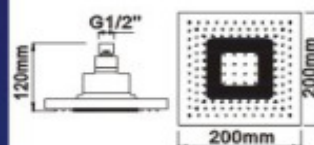

### 603L

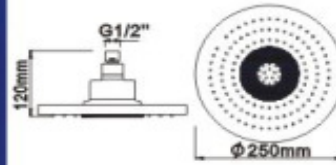

### 604L

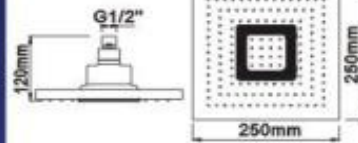

### 605L

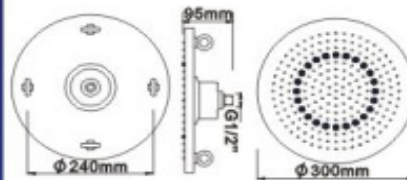

### 606L

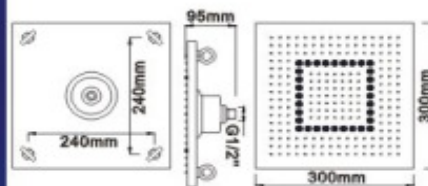
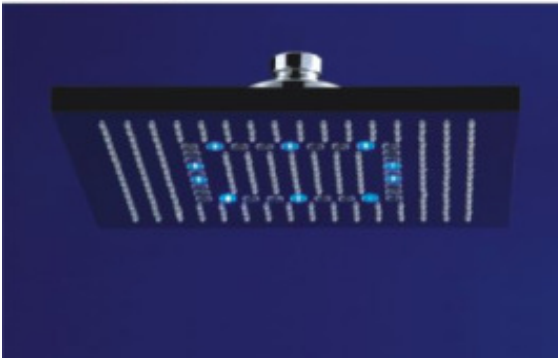



## 607L

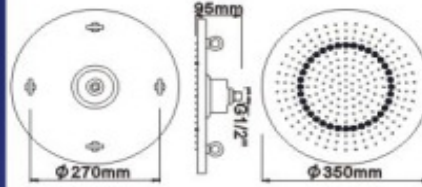

## 608L

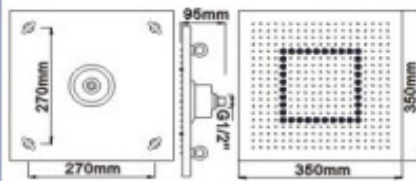

## 609L

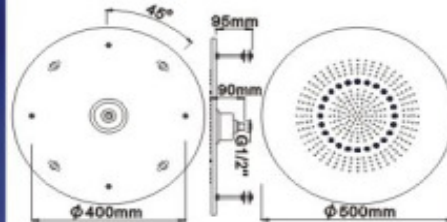
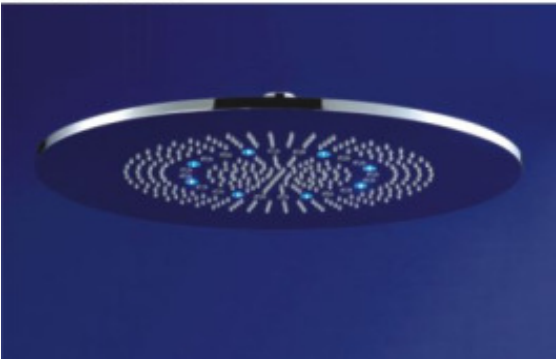

## 610L

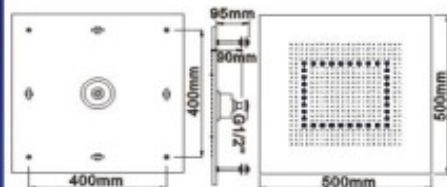





C5-1



C6-1



C8-1



Y6

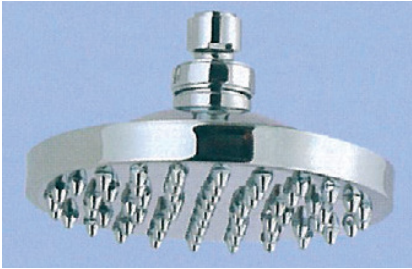

Y8



Y8K



Y10



Y12



H1

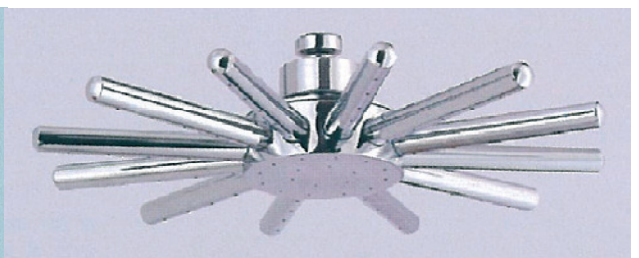

H5



H3

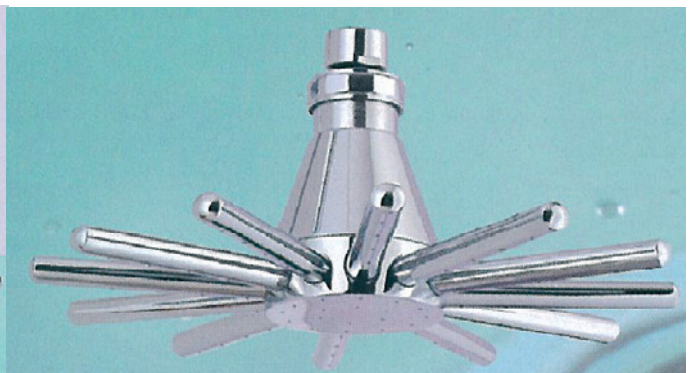



H4

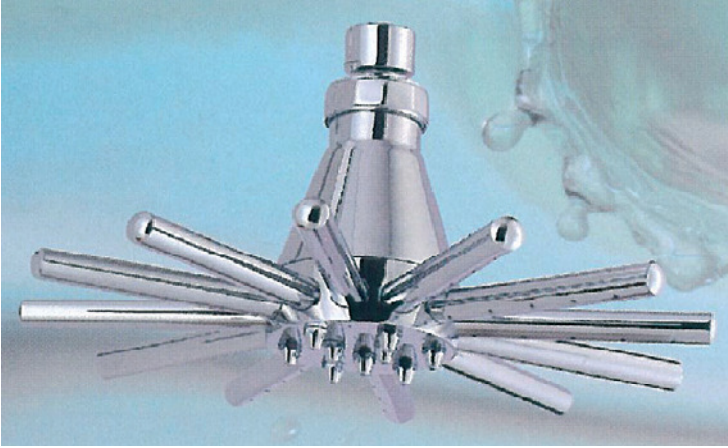

T10-BARRA

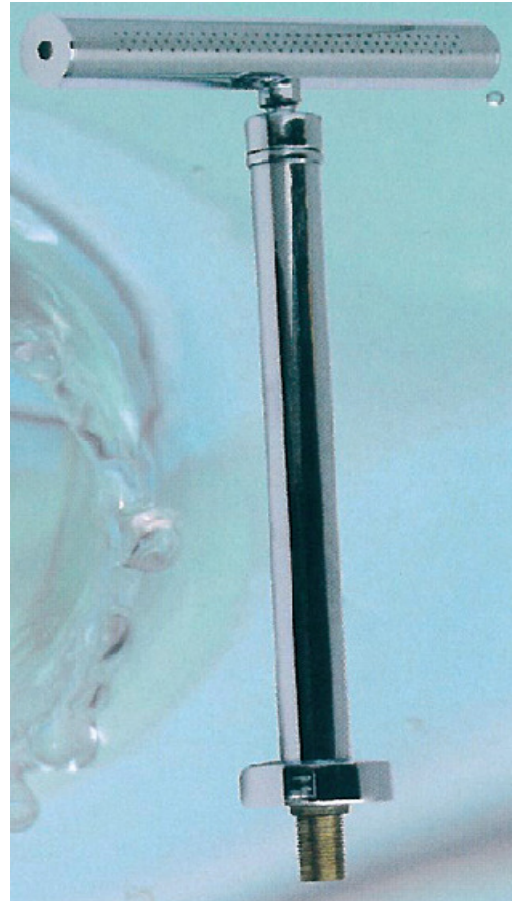

12484



12484-cr



12485-cr



12500-cr



R0A0901



R0B0901



R0C1001



R0G0801



R0G0802



R0G0804

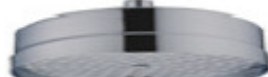

R0I0801



R0I0802



R0I0803



R0I0804



R0E0901



R0E0902



R0F0903



R0B0801



R0B1001

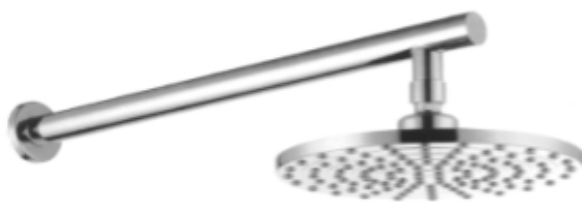

91101  
Polished Chrome  
wall-mounted brass shower set  
rociador ducha de empotra



91102  
Polished Chrome  
wall-mounted brass shower set  
rociador ducha de empotra



## BRACOS PARA CHUVEIROS







tipo ajustable

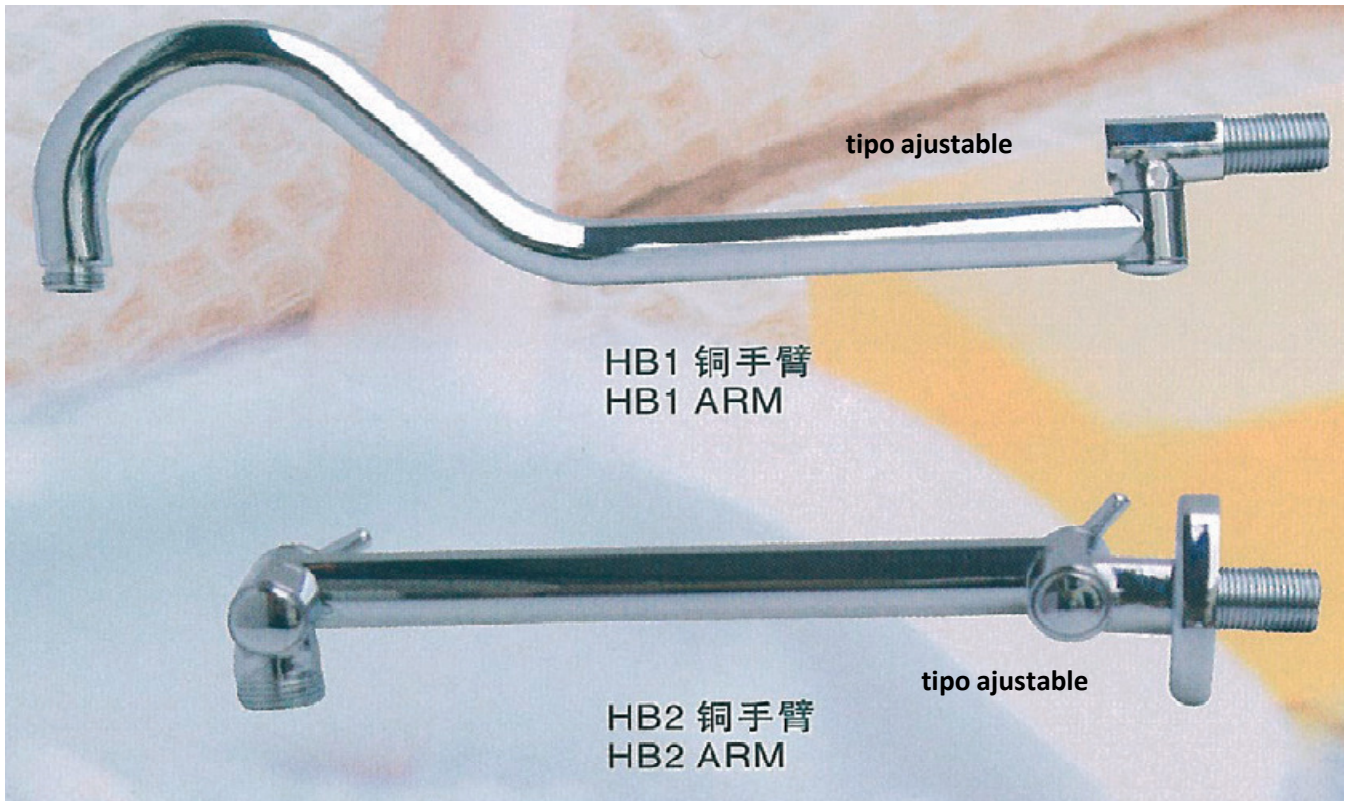

ROJ0801



ROJ0802



ROJ0803



ROJ0804



ROQ0301/G0016



ROQ0401/G0017



G0001



G0002



G0014



G0015



G0016



G0017



G0018



G0019



G0020



G0021



G0022



G0023



G0017

